

100 / 200 / 350 / 400 / 450

Rev 5 April 2026 to Present

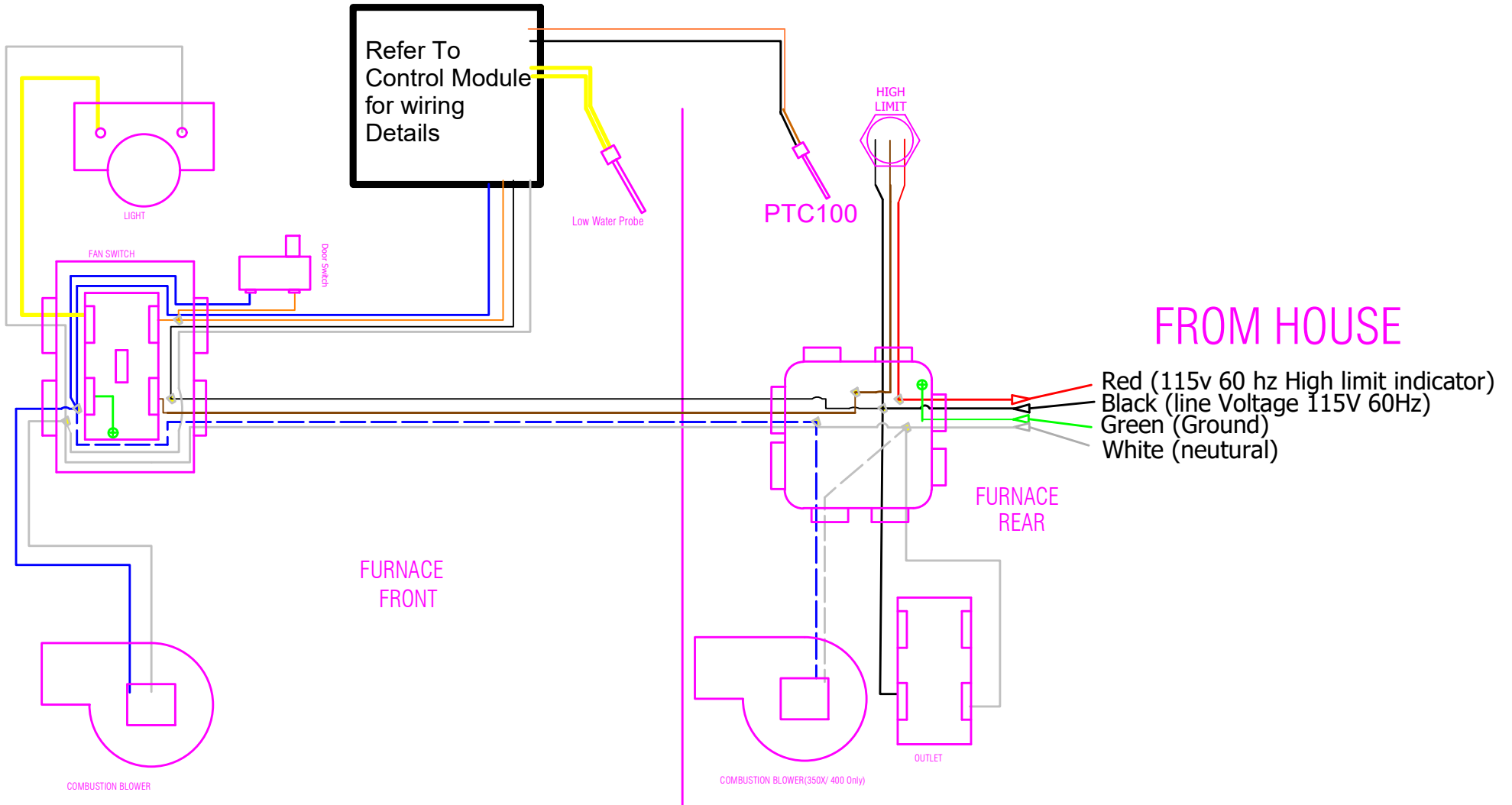

100 / 200 / 350 / 400 / 450

Rev 4 Spring 2016 to Present

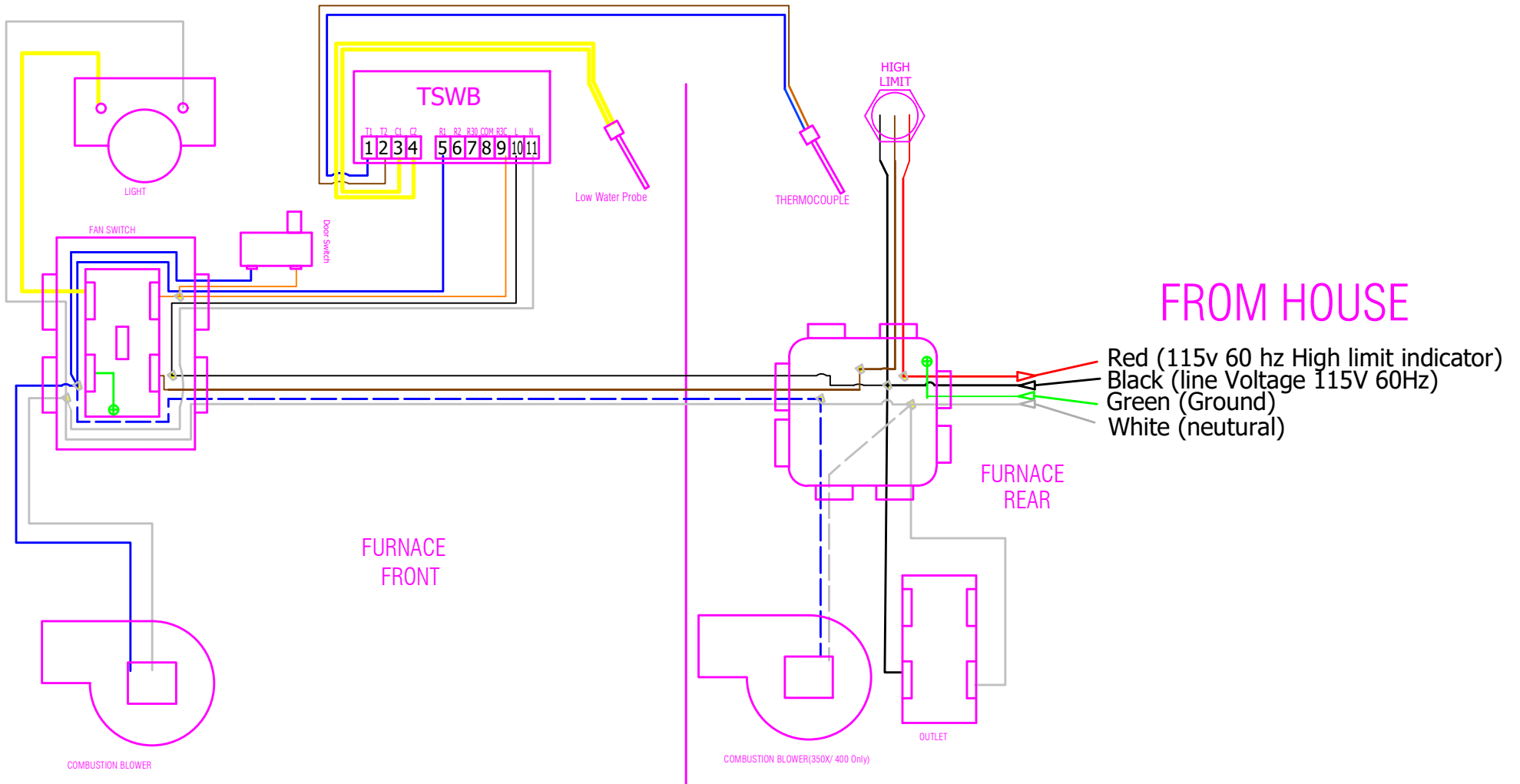

600 DCSS

2016 to Present

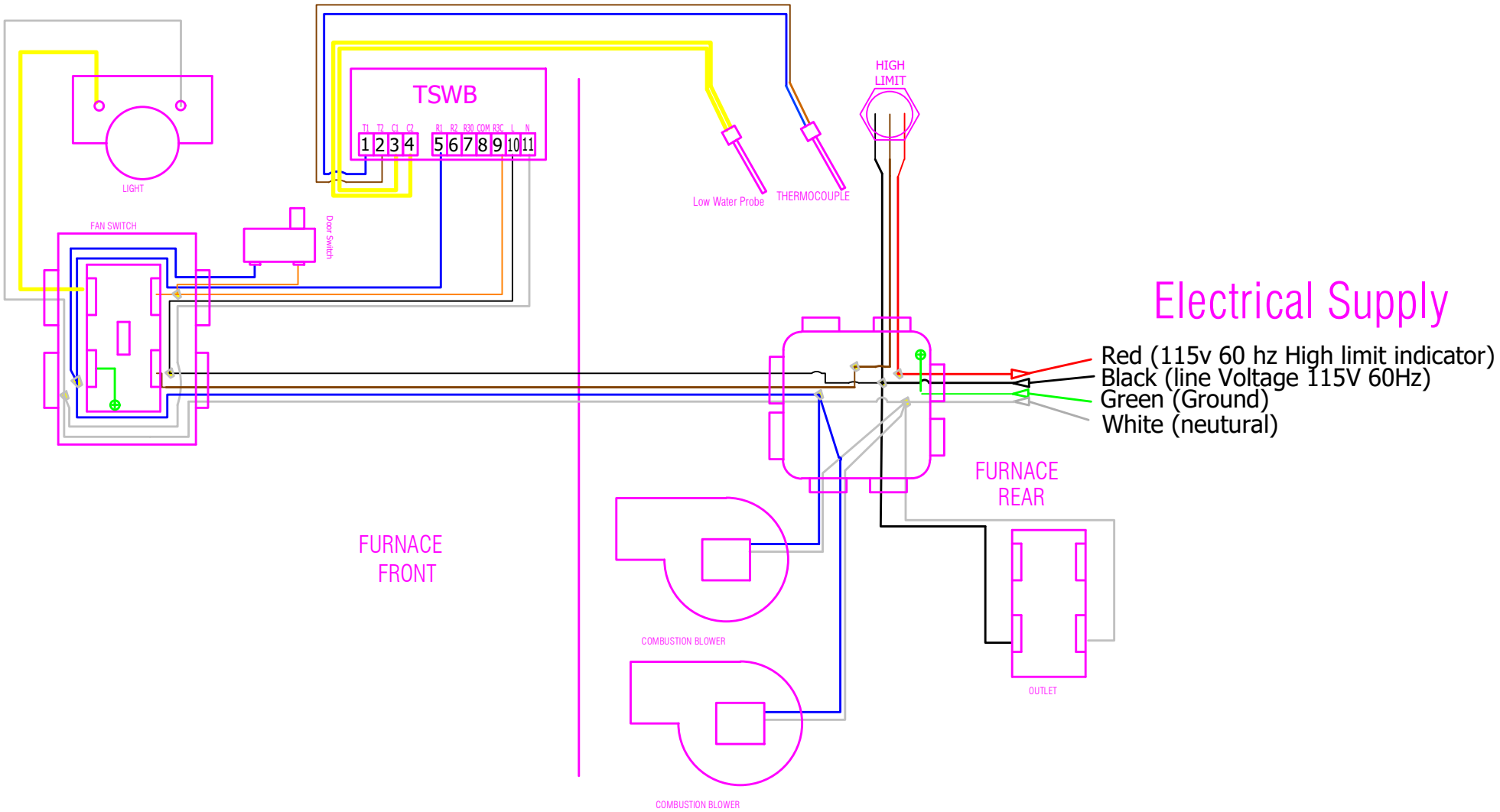

200/400 Oil Gun Wiring Diagram

Rev 4 Spring 2016 to Present

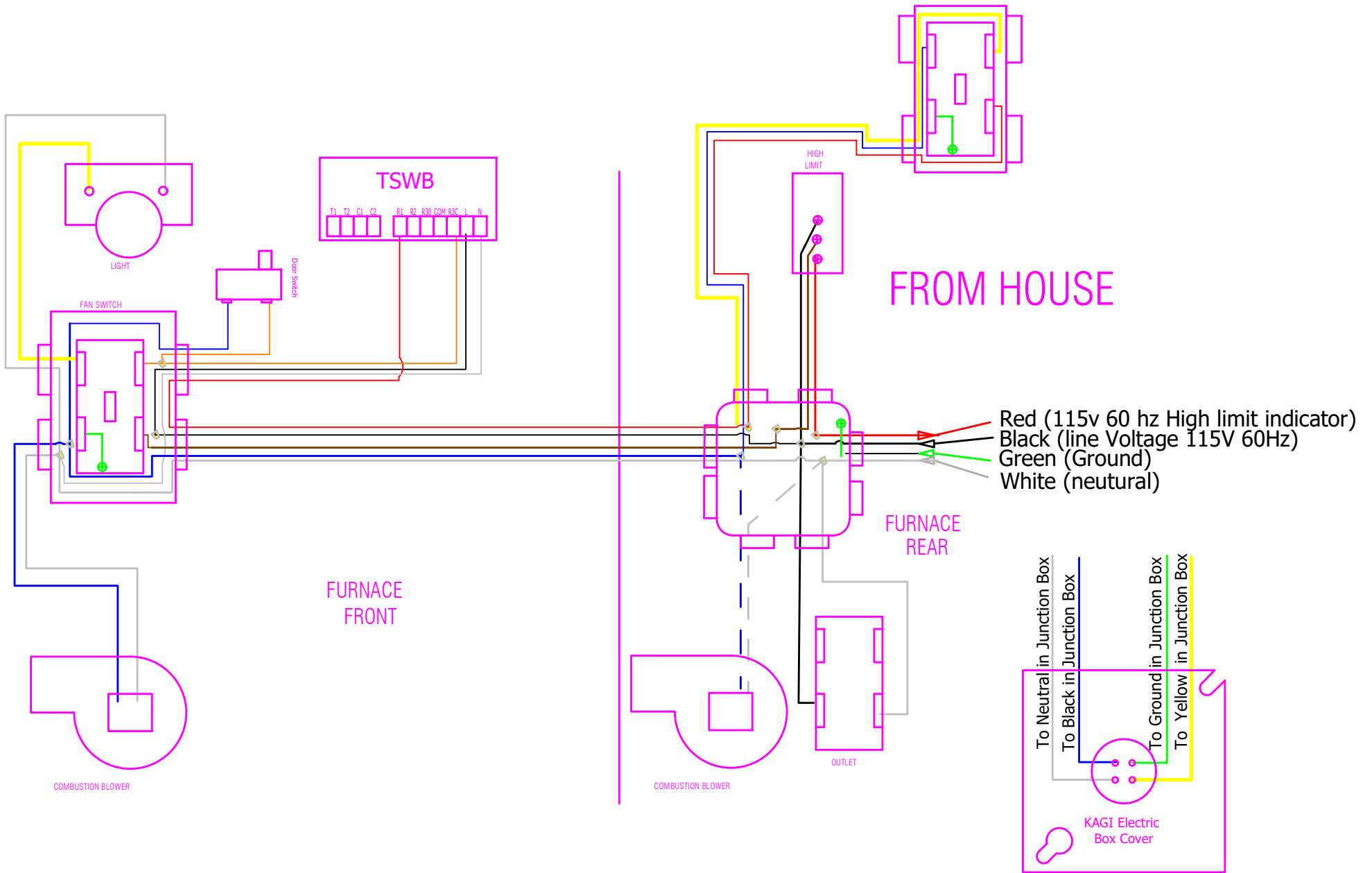

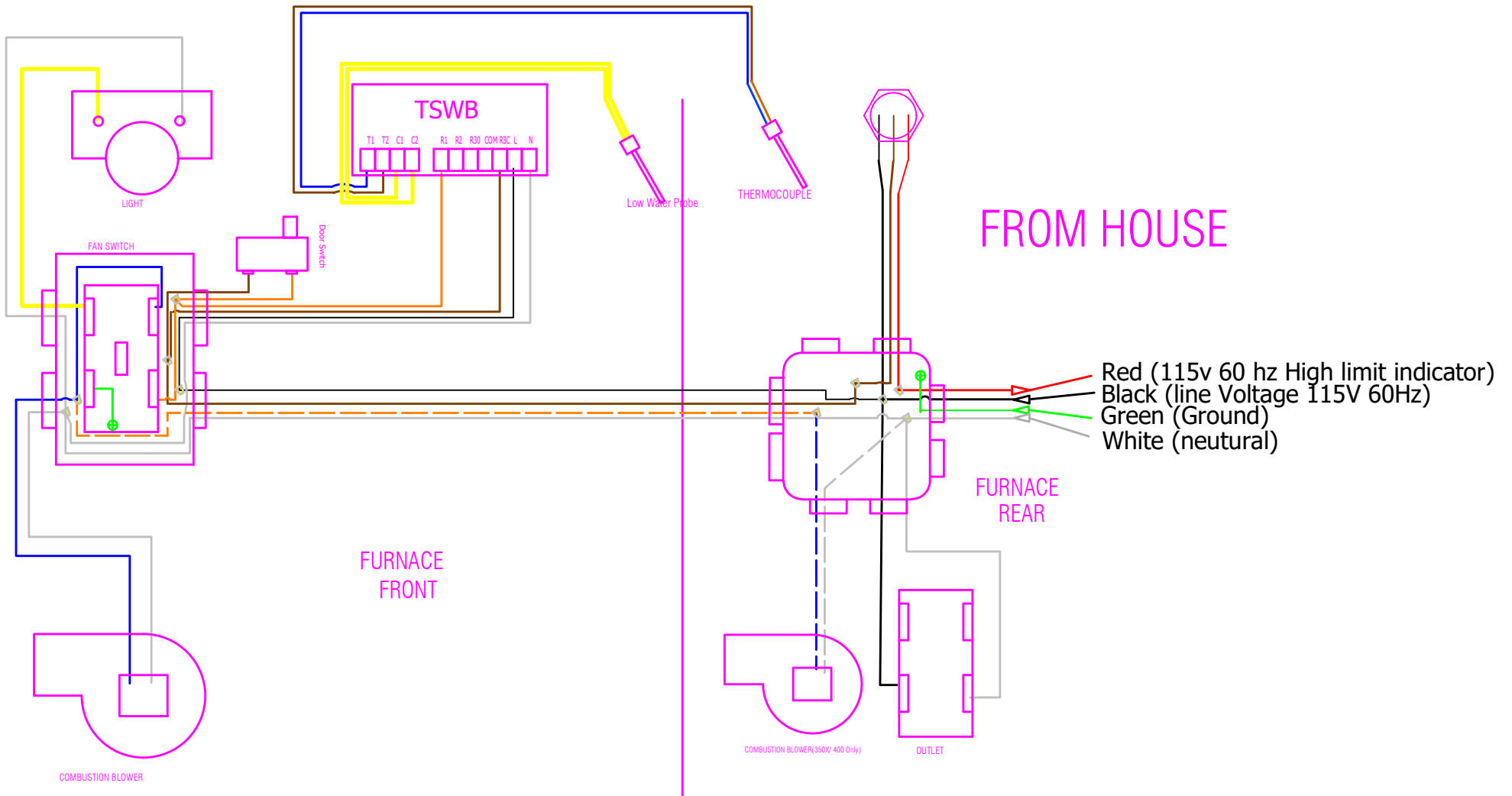

400 oil burner Wiring Diagram

Rev 3 Summer 2015 to spring 2016

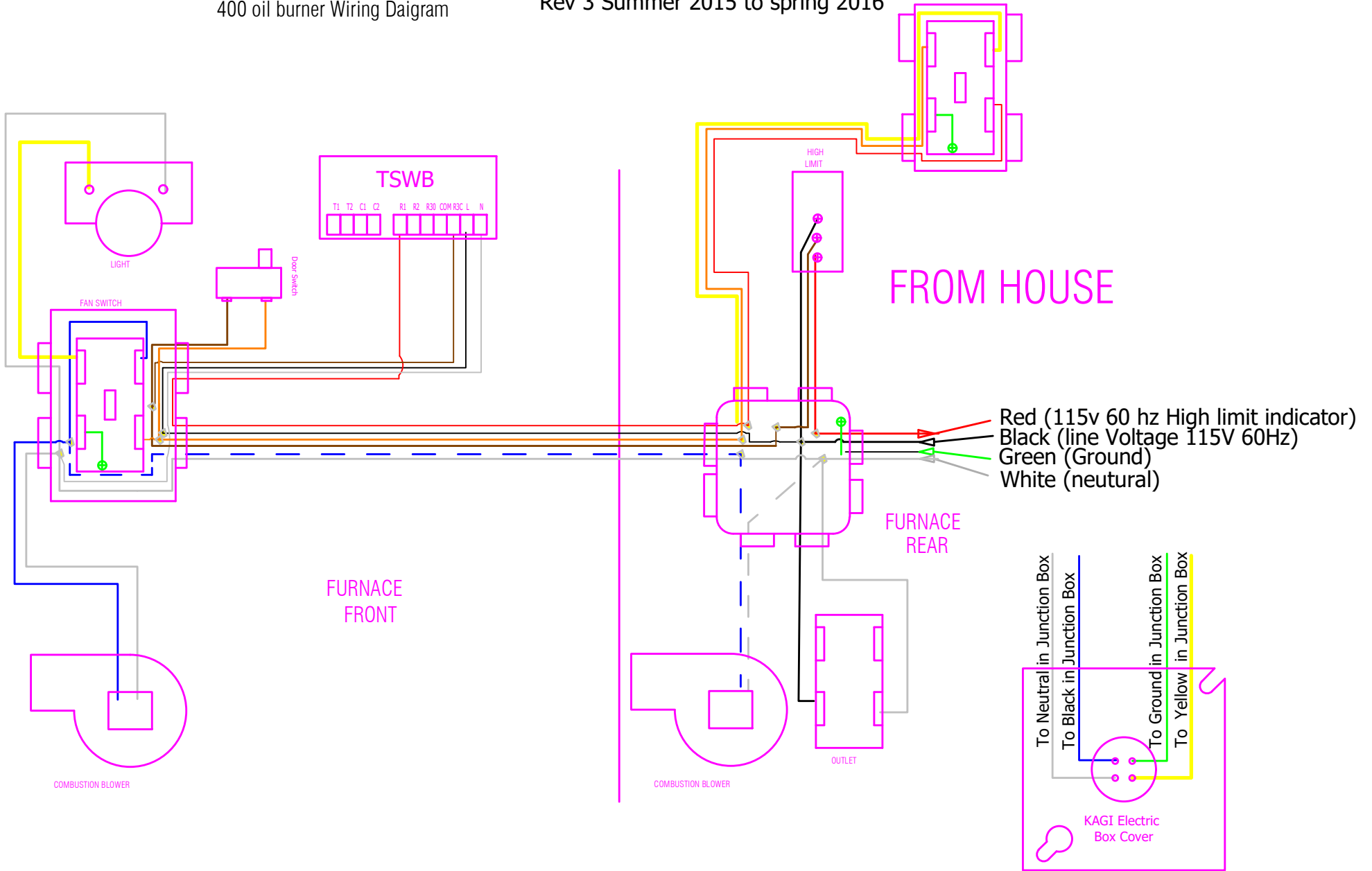

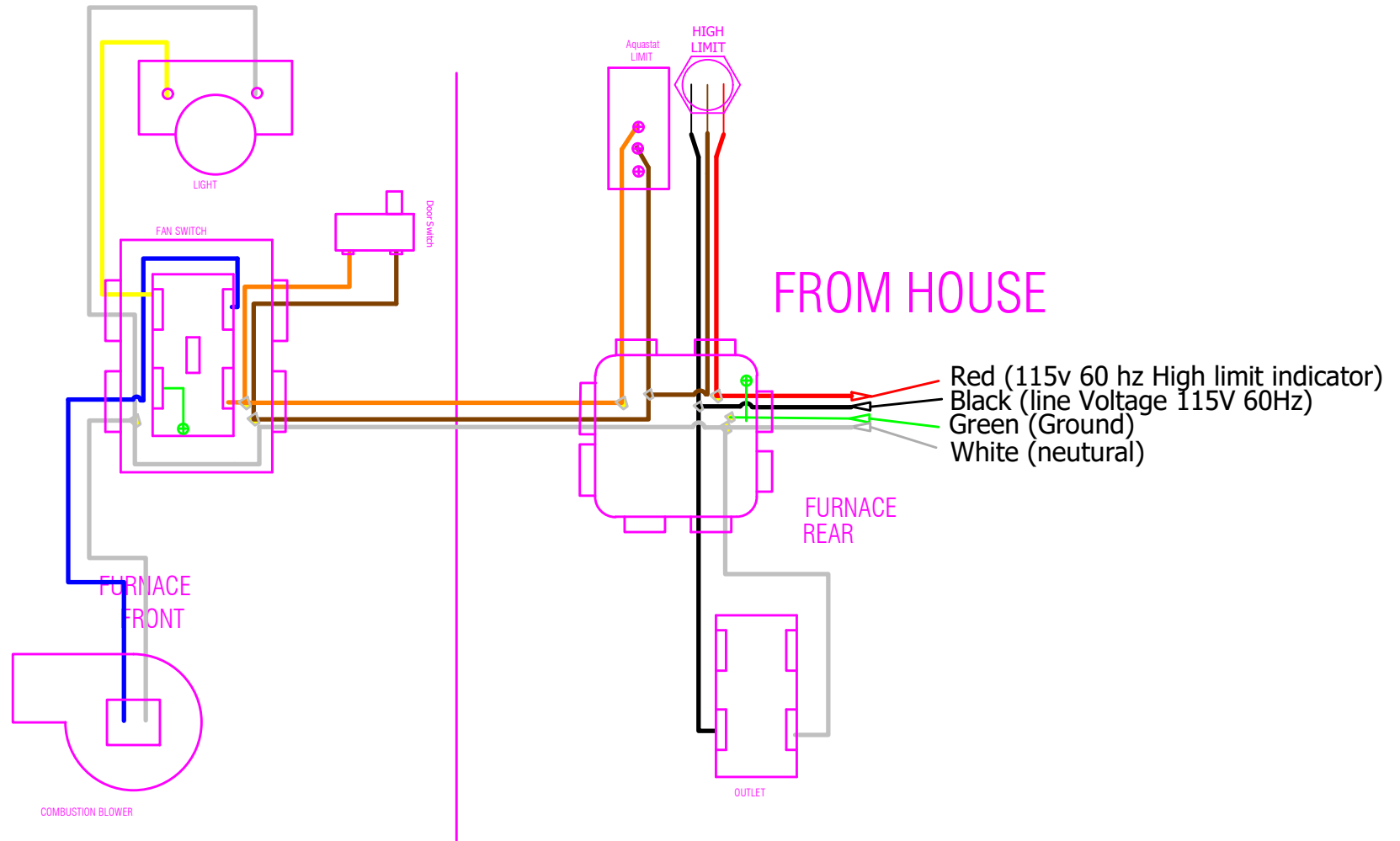

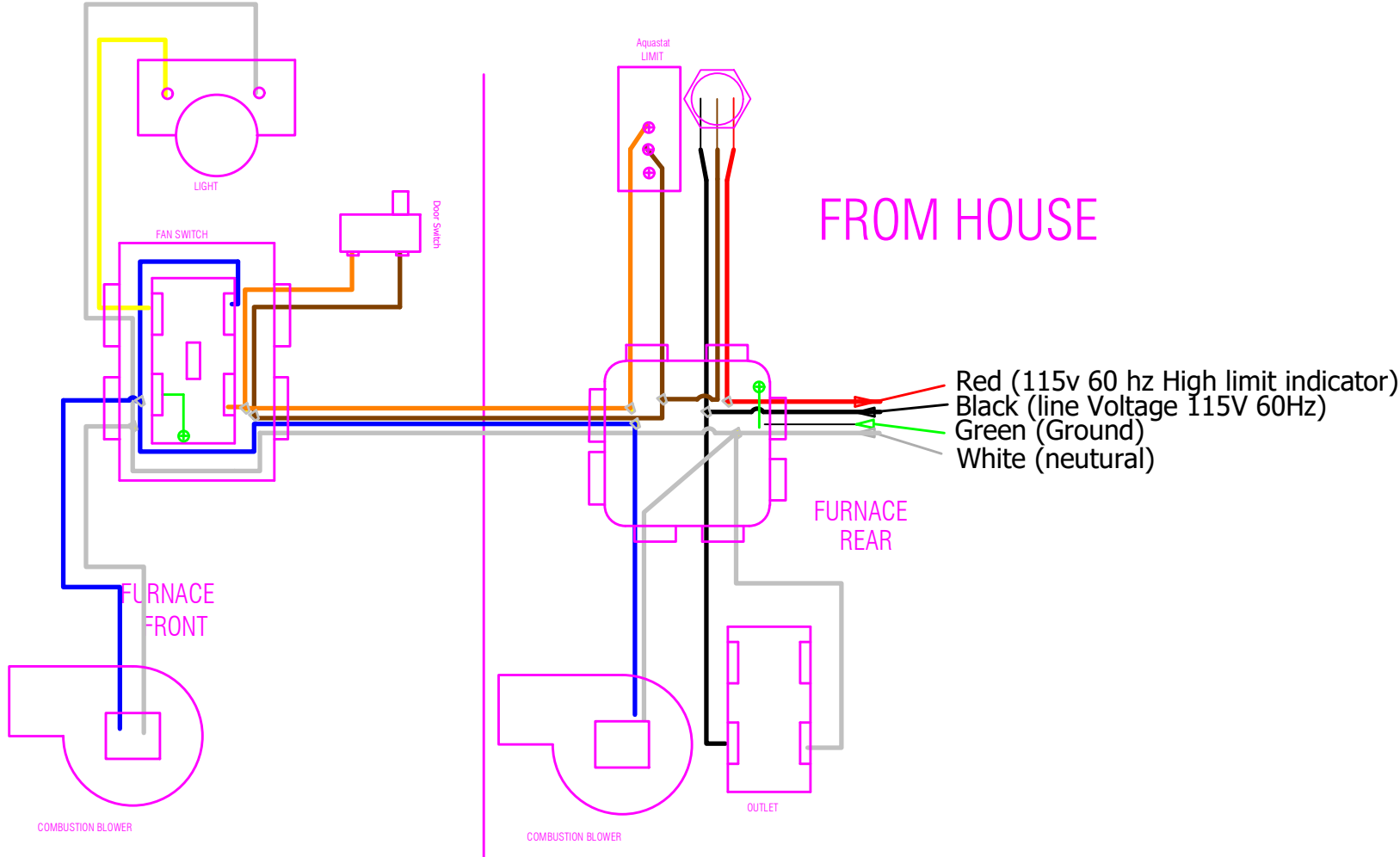

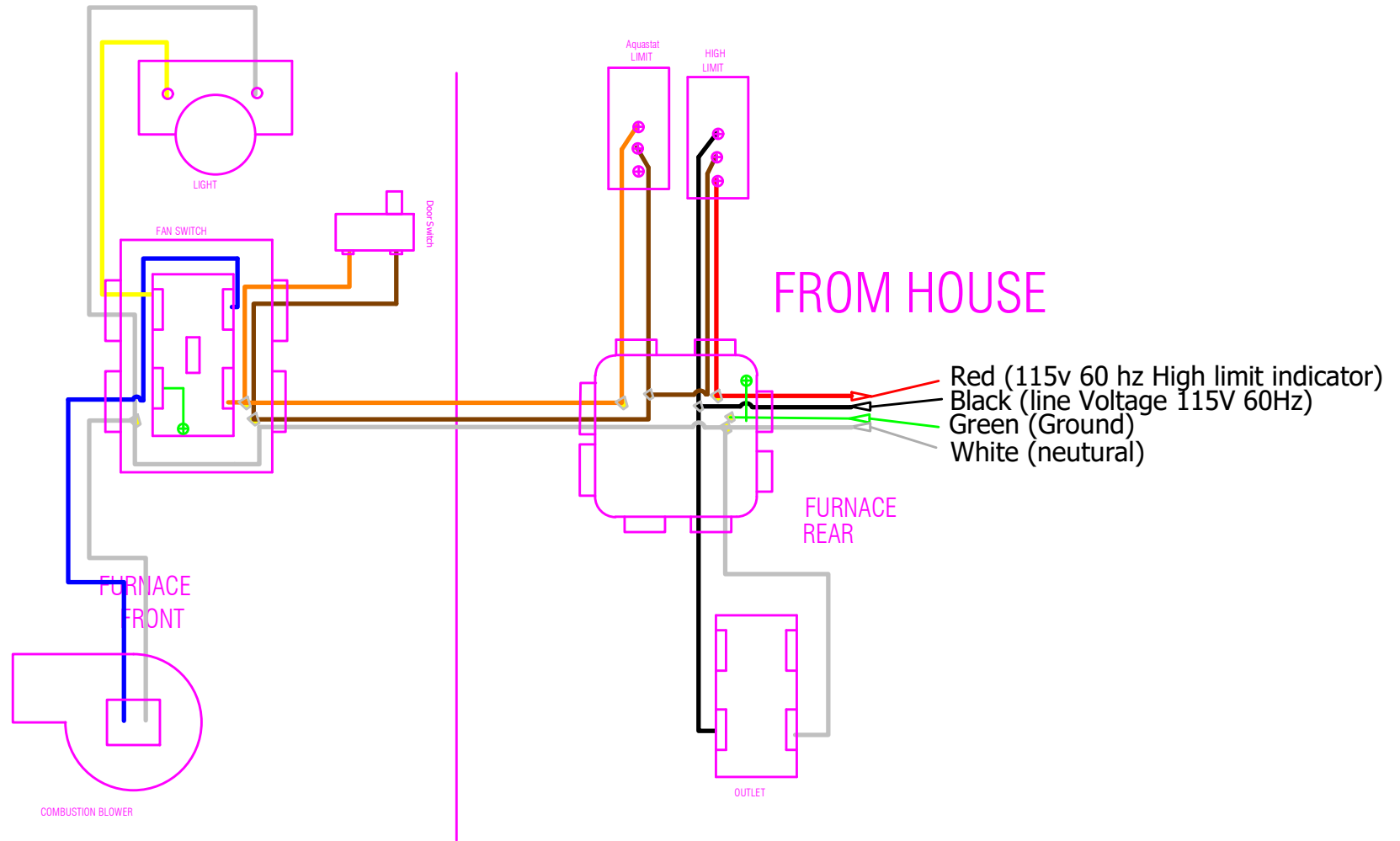

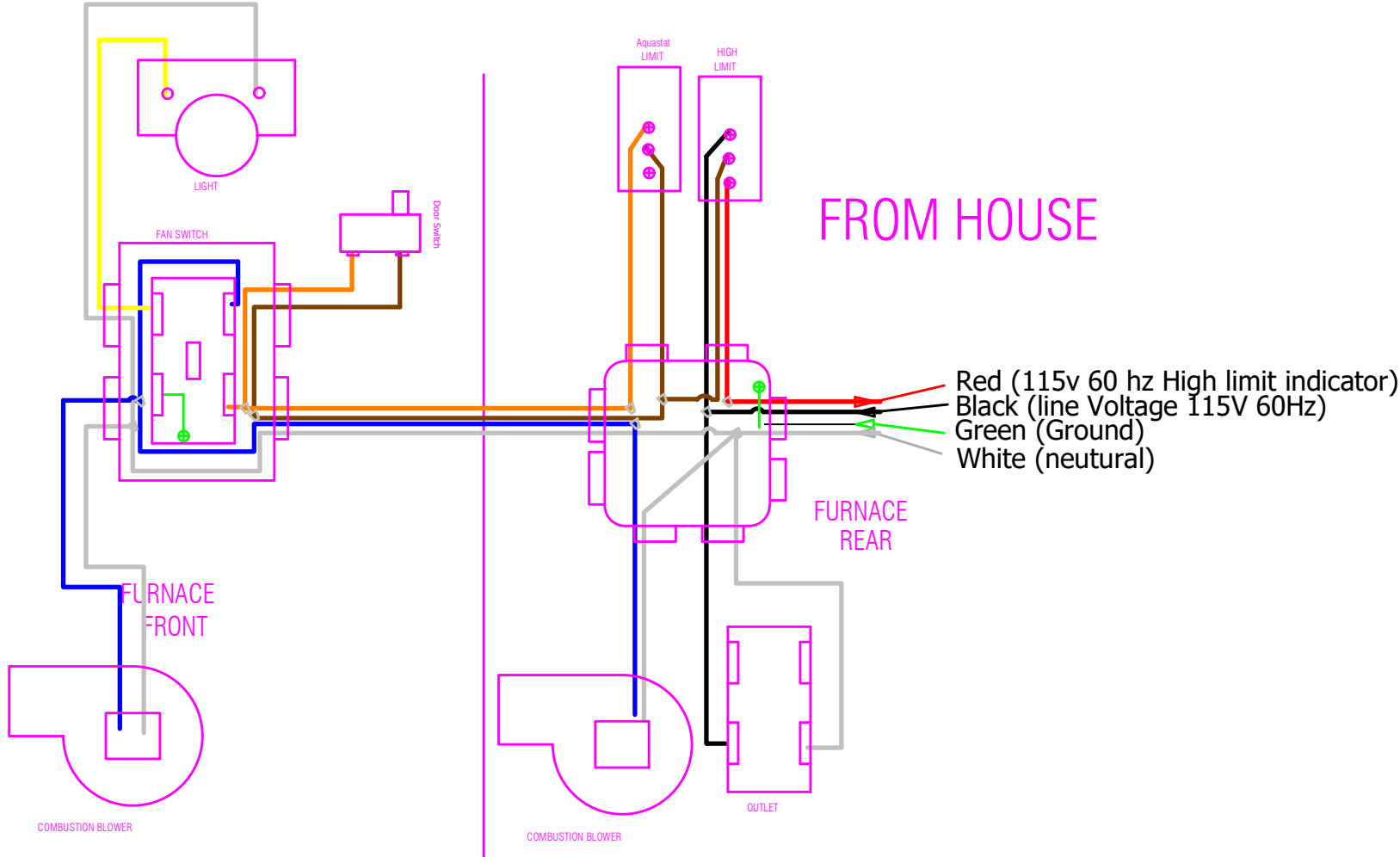

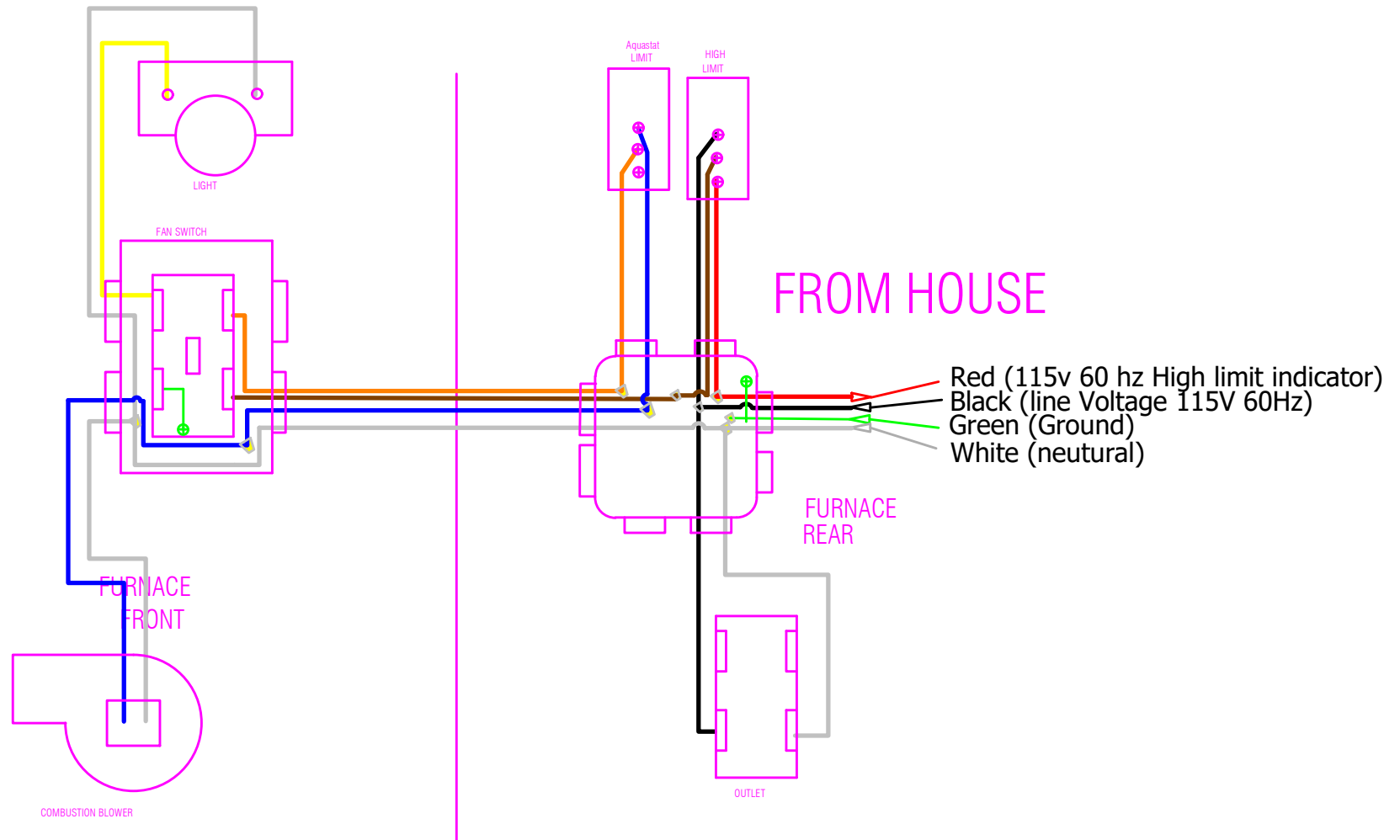

400 DCSS Wiring Diagram

Initial Wiring pre 2011

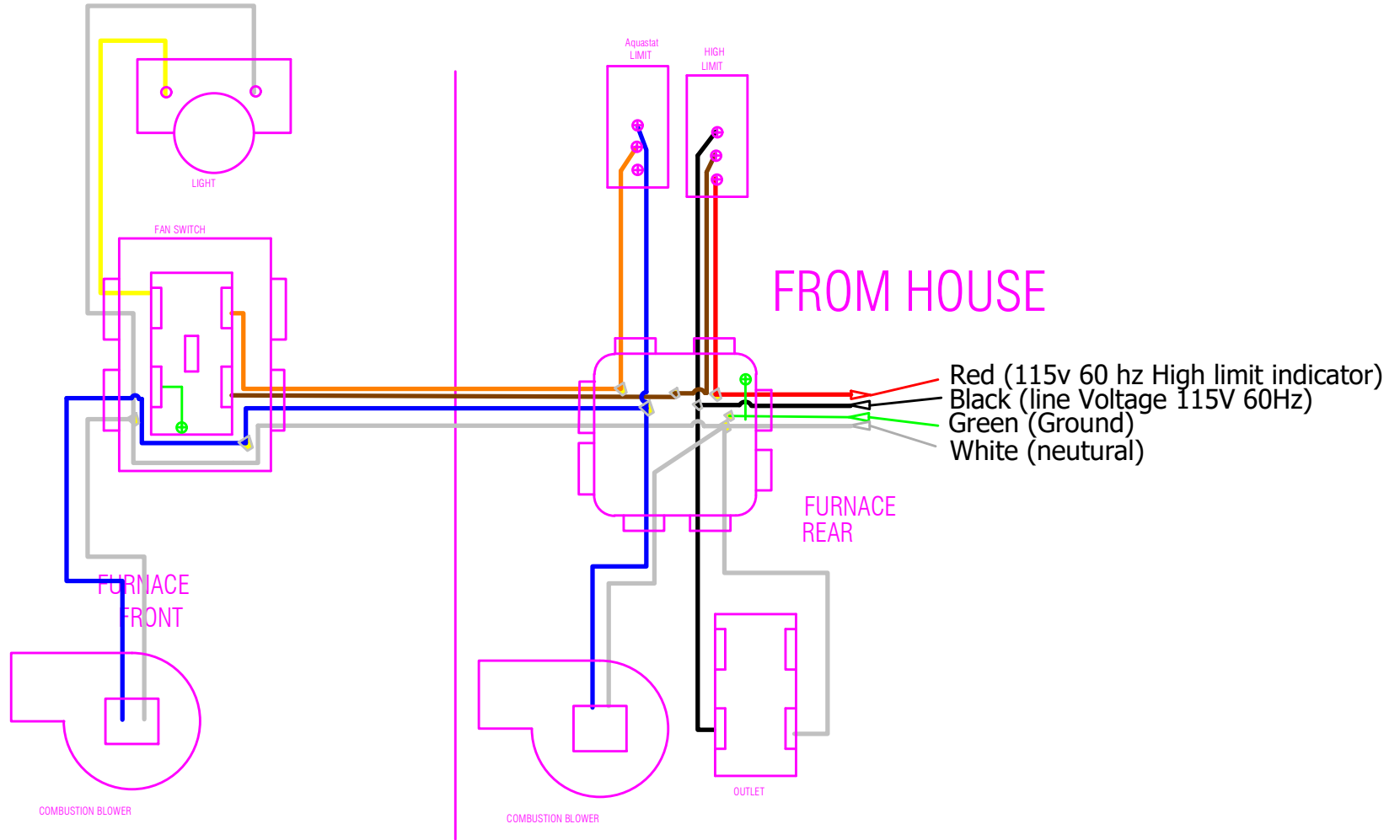

200 SSR II Wiring Diagram

Rev 1 - 2011 to Fall 2012

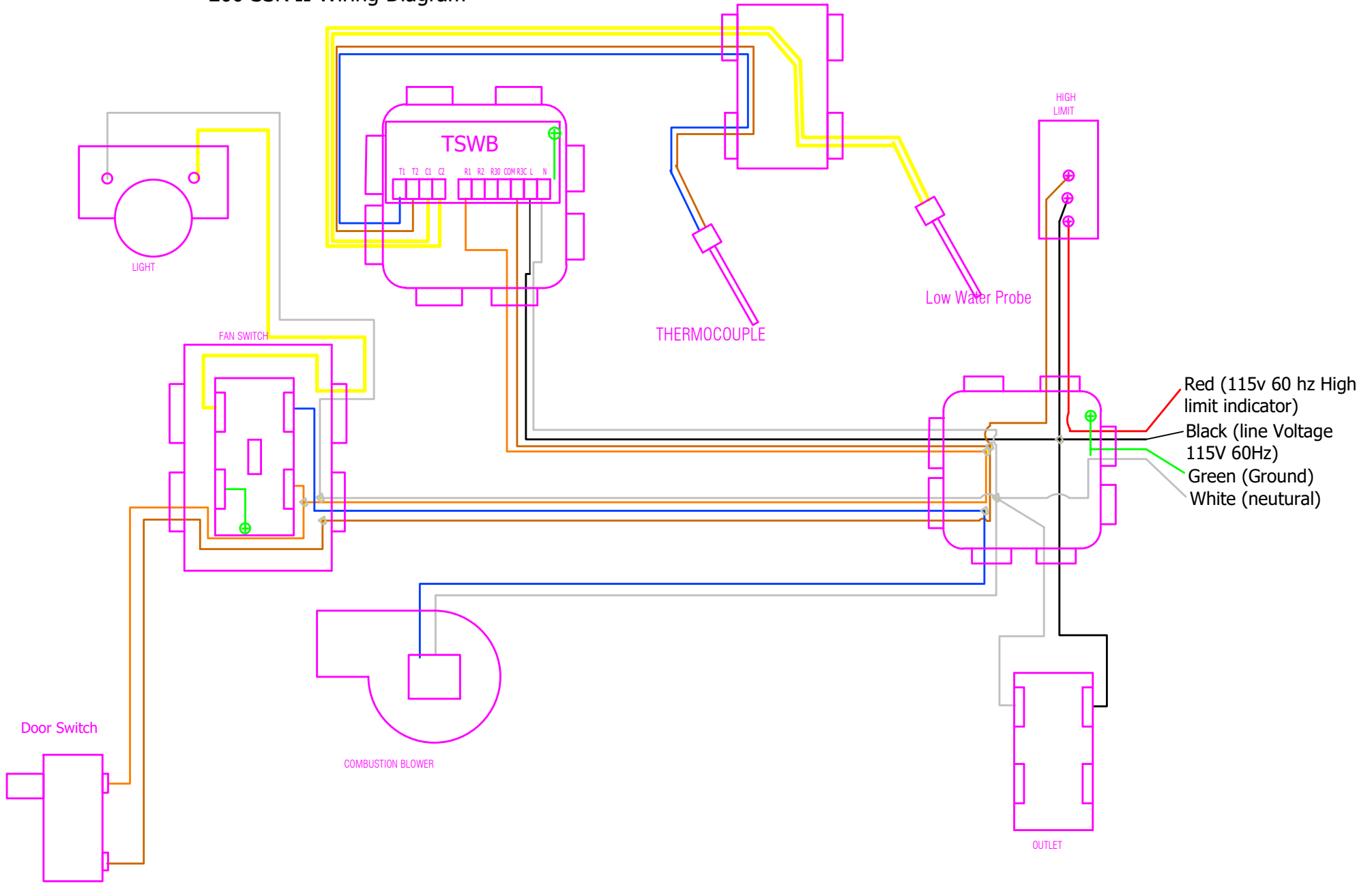

rev 2 with AFS

400 DCSS Wiring Daigram

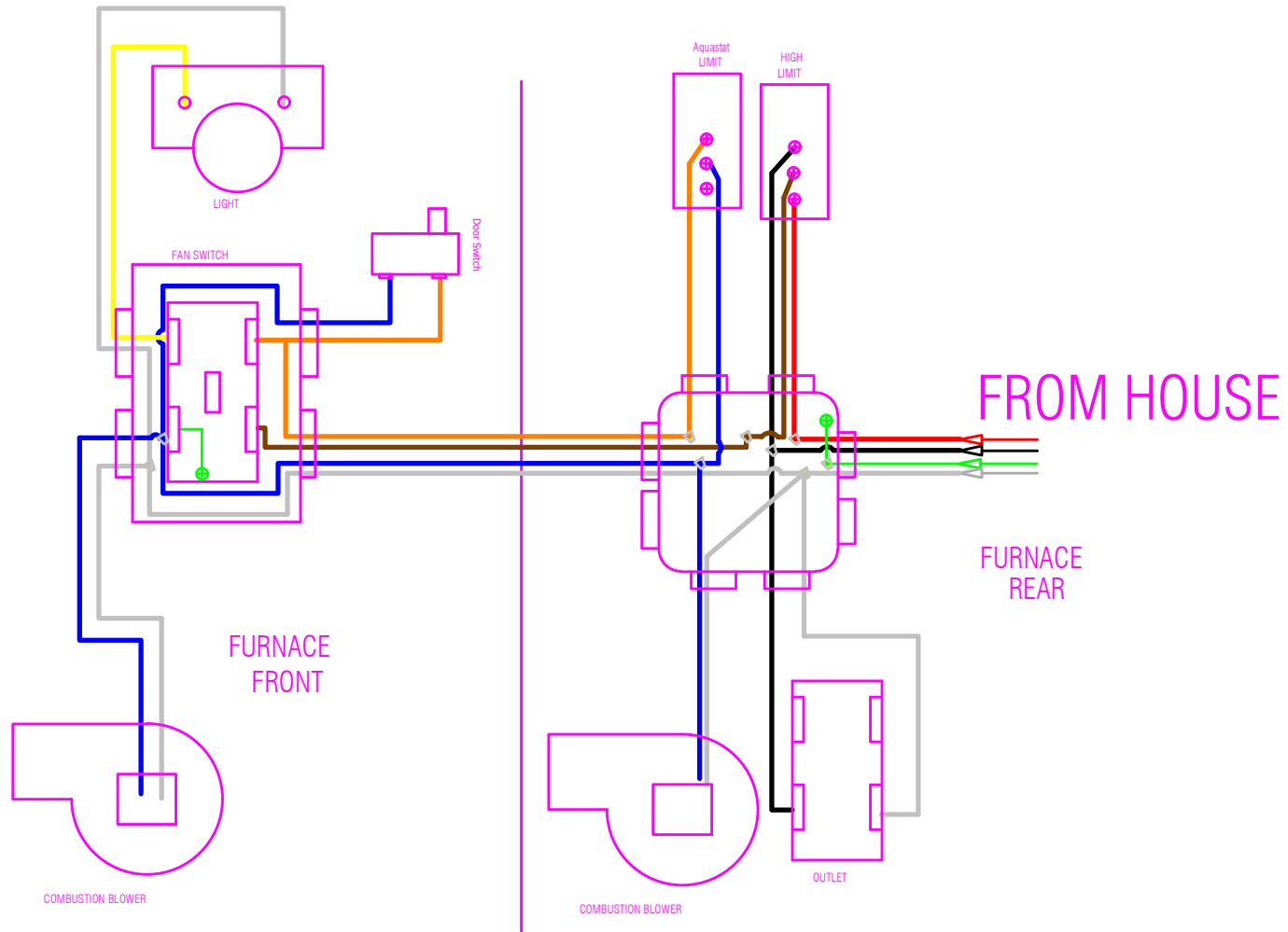

rev 2 with AFS

100 CSS & 200 CSS Wiring Daigram

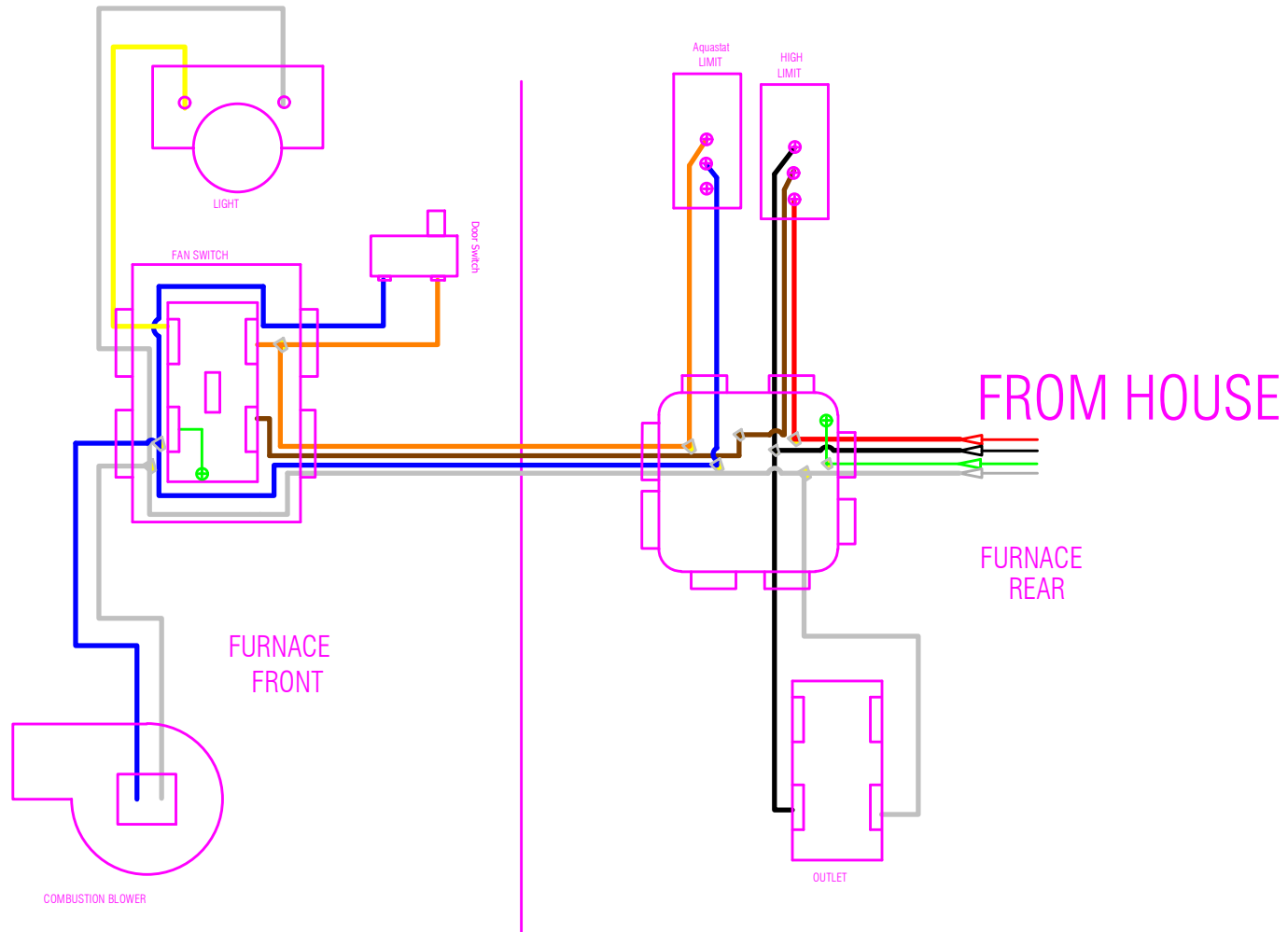

200 SSR II Wiring Diagram

rev 2 with AFS

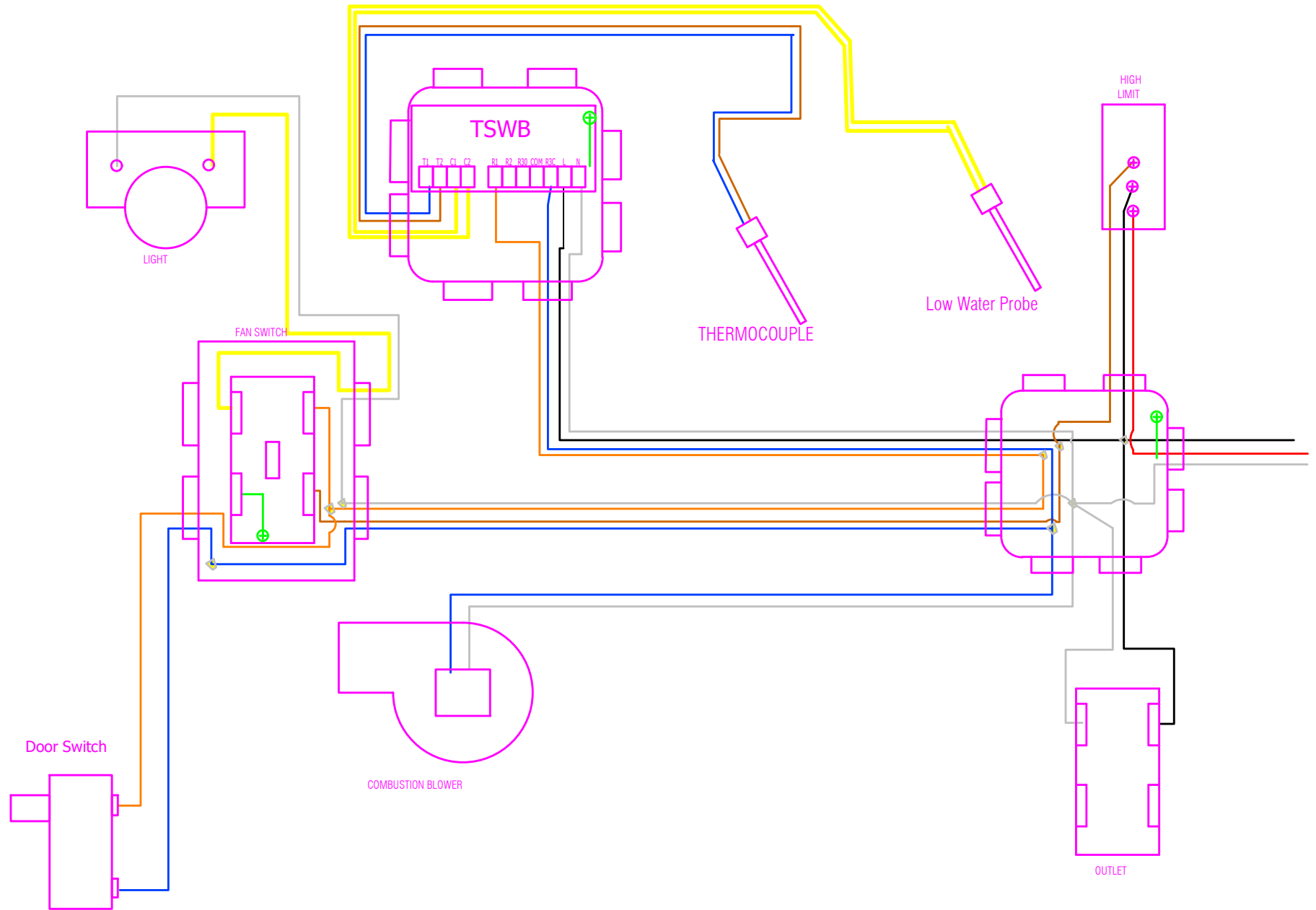

200 CSS Oil Wiring Daigram

rev 1 with AFS

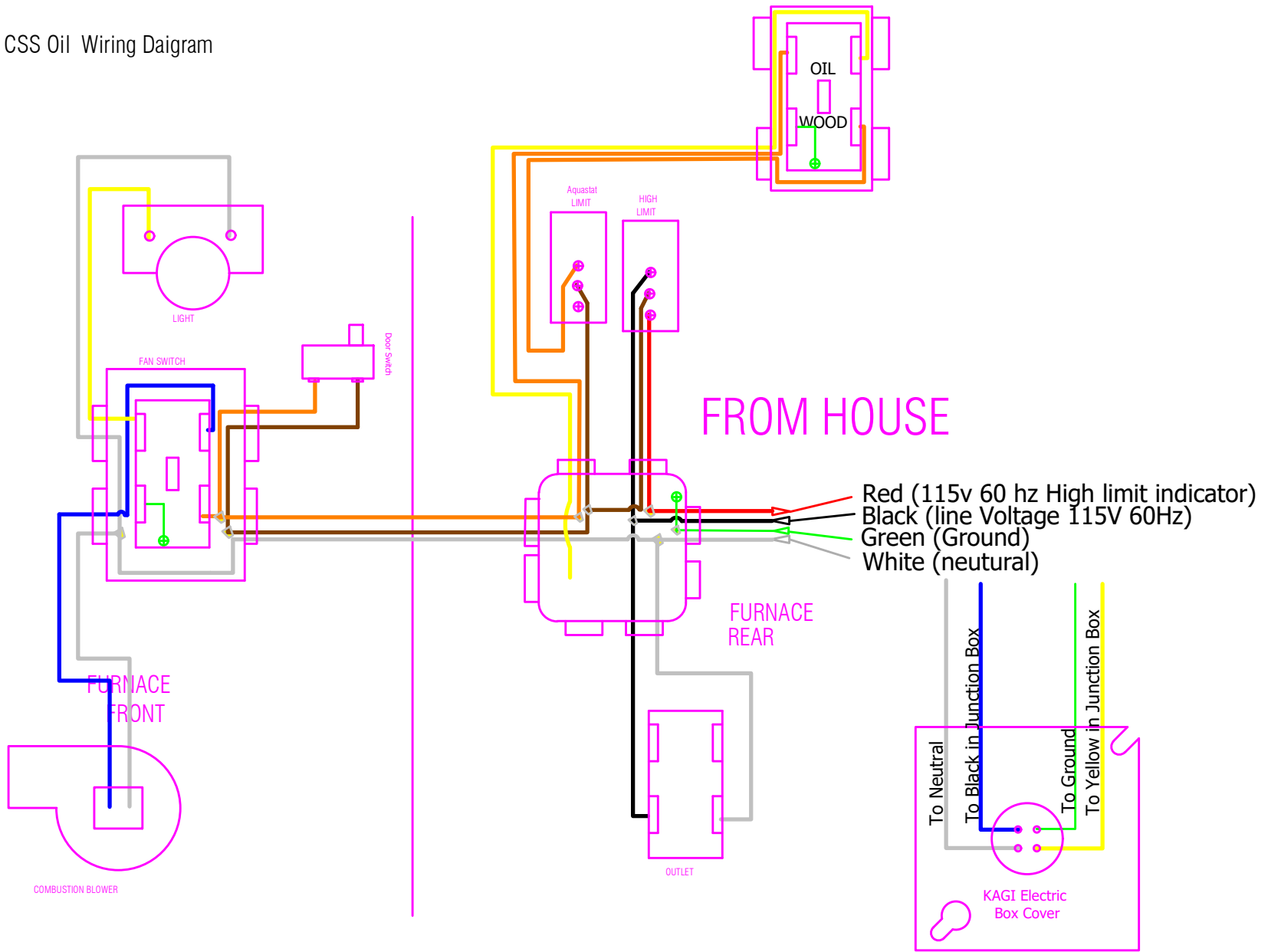

400 oil burner Wiring Daigram

rev 1 with AFS

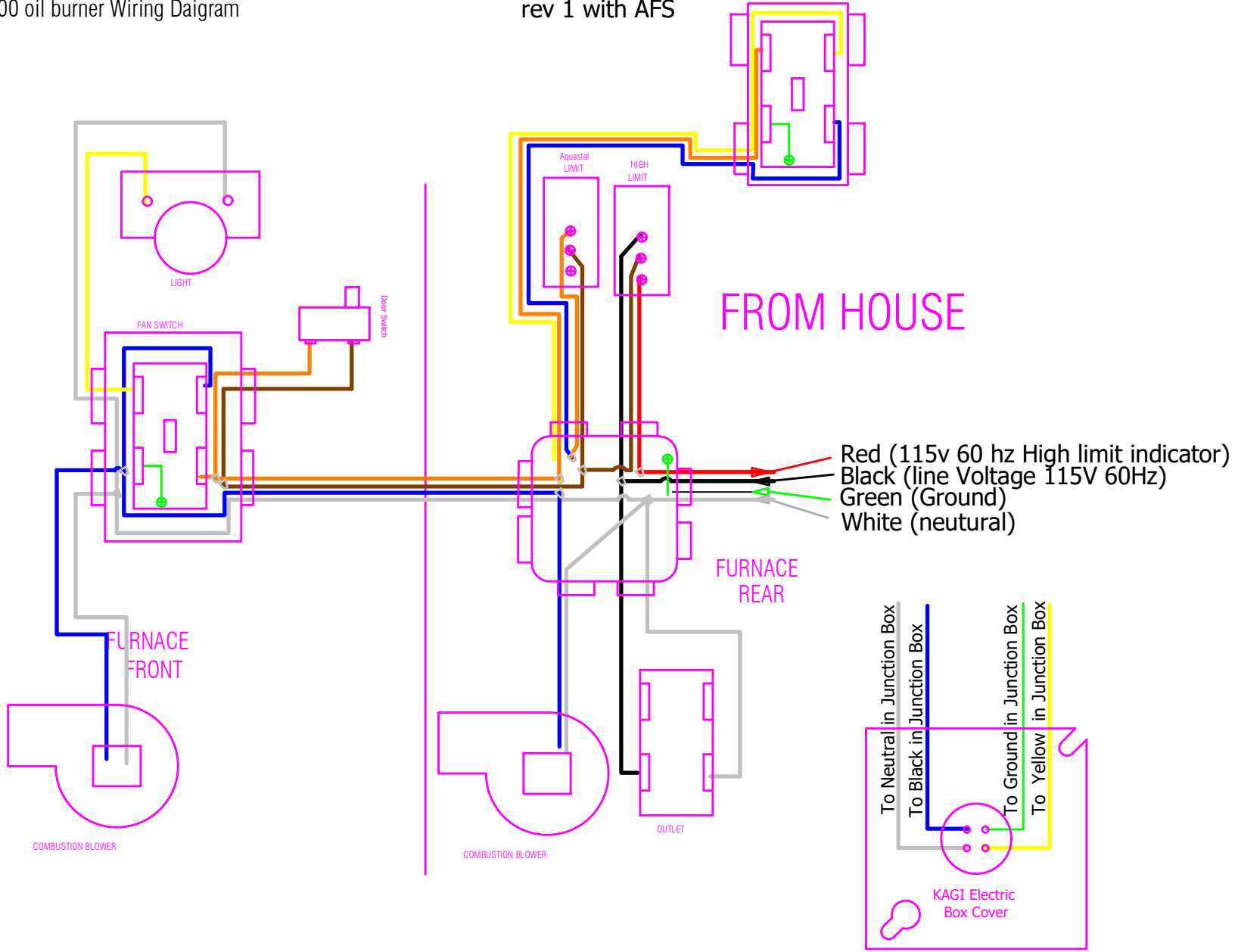

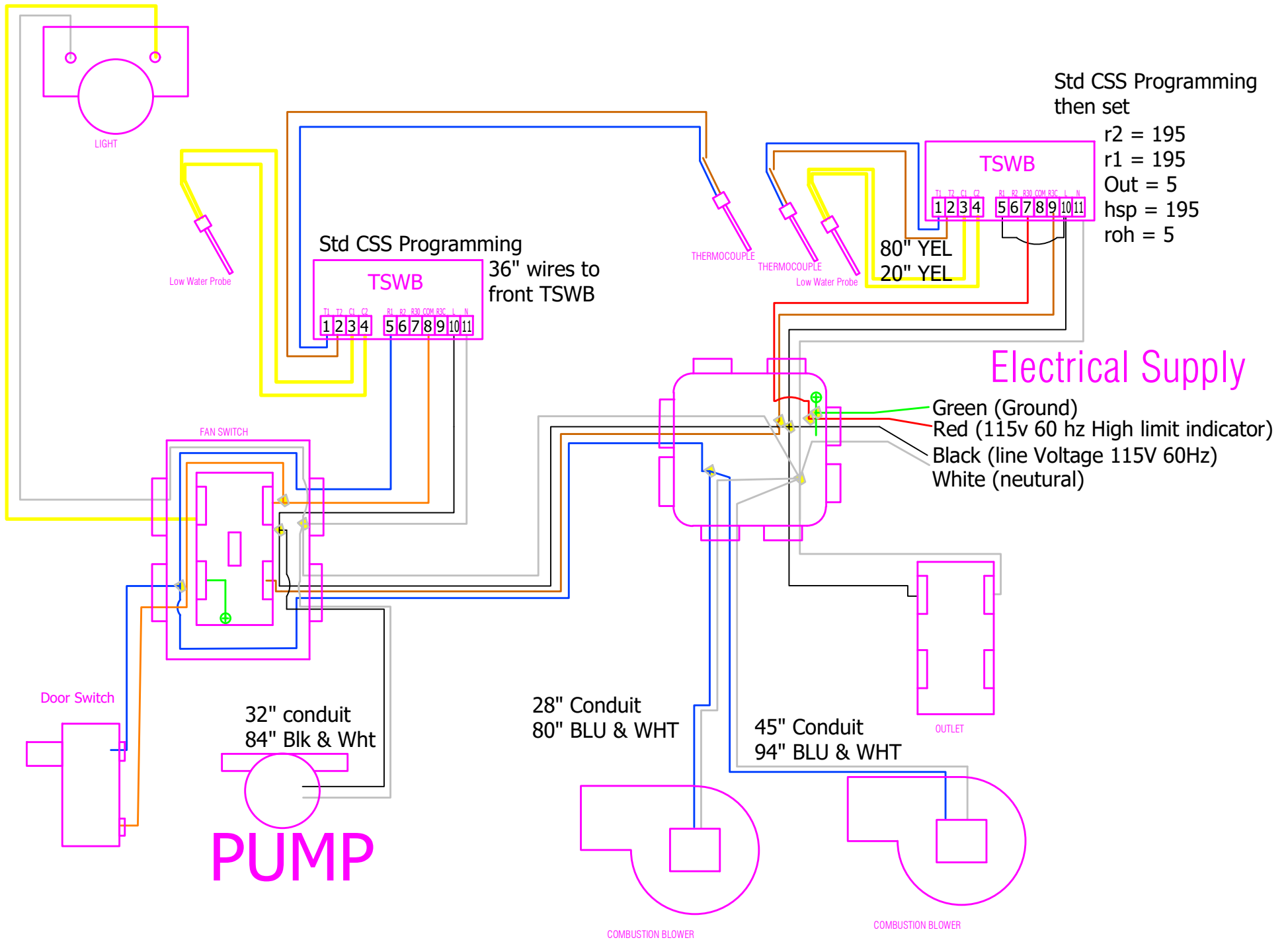

2015 to 2016

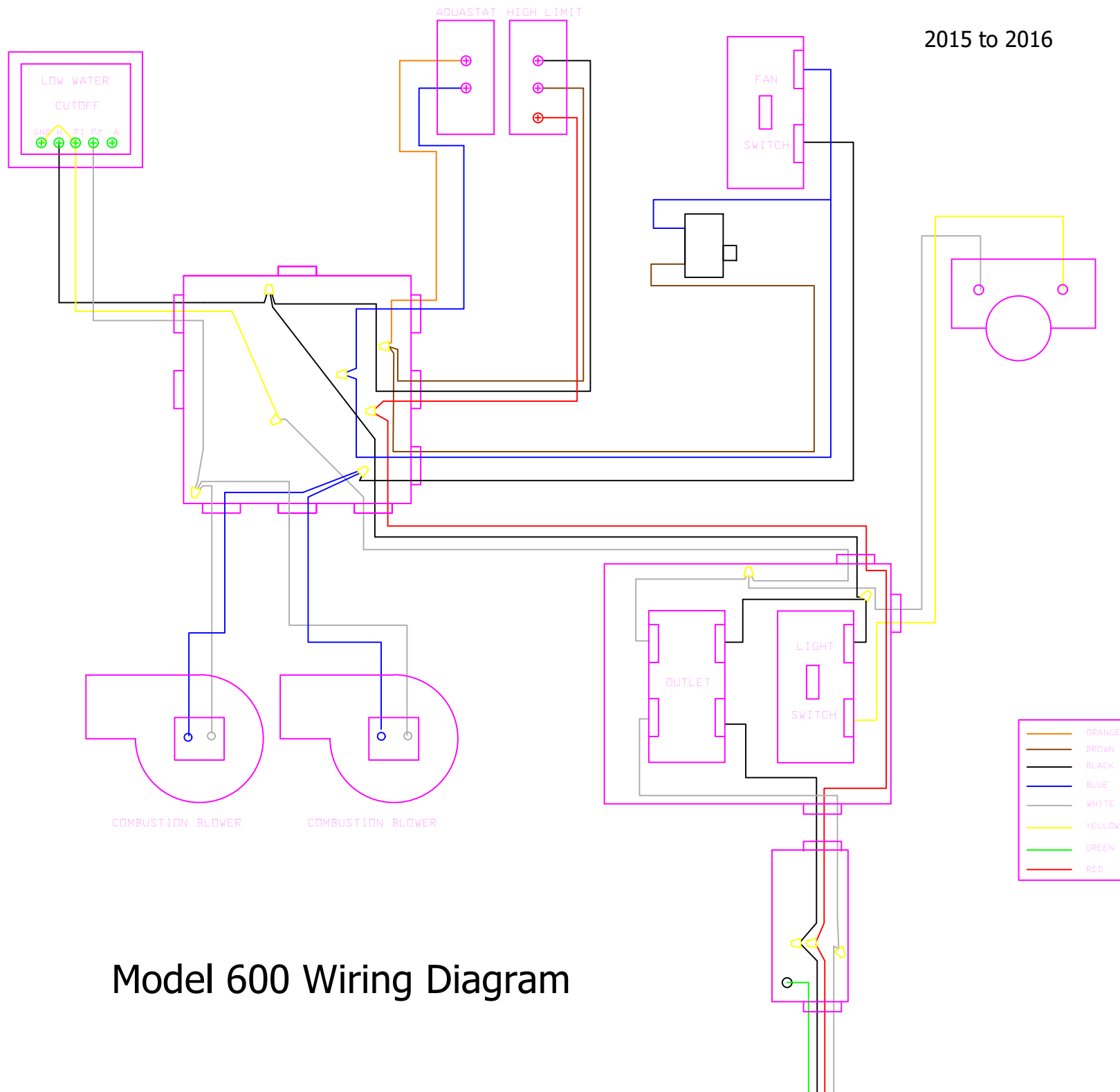

Model 600 Wiring Diagram

600 DCSS

2015 to 2016

