

# **HEATMOR**

**STAINLESS STEEL**

## **Outdoor Furnaces**

***Coal Burner***

**SAVE THESE INSTRUCTIONS**

**Manuel en Français disponible en ligne:  
[www.HEATMOR.com](http://www.HEATMOR.com)**

When these safety symbols appear on the following pages, they will alert you to the possibility of serious injury if you do not comply with the corresponding instructions. The hazard may originate from something mechanical or electrical shock. Please read the instructions carefully.



When you see this safety symbol on the following pages, it will alert you to the possibility of damage to your HEATMOR™ Stainless Steel Outdoor Furnace if you do not comply with the corresponding instructions. Please read the instructions carefully.



The HEATMOR™ Stainless Steel Outdoor Furnace is certified to offer safe service provided it is installed, operated and maintained in accordance with the instructions contained in this manual.

Proper personal protective equipment, (PPE), **MUST BE WORN AT ALL TIMES** when servicing and maintaining any of the HEATMOR™ Stainless Steel Outdoor Furnace product line.

	Page #
<b>TABLE OF CONTENTS</b>	
NOTICE TO THE READER	6
CERTIFICATE OF COMPLIANCE	7
<b>1 HEATMOR™ STAINLESS STEEL FURNACE MODELS</b>	<b>8</b>
<b>2 FURNACE SPECIFICATIONS</b>	<b>9</b>
<b>3 FRONT CUT AWAY VIEW OF HEATMOR™</b>	<b>10</b>
A Furnace Parts List	
<b>4 REAR CUT AWAY VIEW OF HEATMOR™</b>	<b>12</b>
A Furnace Parts List	
<b>5 MINIMUM CLEARANCE SEPARATION SPECIFICATIONS</b>	<b>14</b>
<b>6 WARNINGS AND PRECAUTIONS</b>	<b>15</b>
A Installation	
B Electrical	
C Other	
<b>7 CONCRETE PAD SPECIFICATIONS</b>	<b>17</b>
A Model 100 Pad Specifications	
B Model 200 Pad Specifications	
C Model 400 Pad Specifications	
<b>8 INSTALLATION OF THE HEATMOR™ FURNACE</b>	<b>20</b>
A Equipment Required	
B Placing the HEATMOR™ on the Concrete Base	
C Filling the HEATMOR™ Outdoor Furnace Initially with Water	
D Maintaining Heat Transfer Fluid (HTF) in the Bladder and HEATMOR™	
E Low Heat Transfer Fluid (HTF) Condition	
F Initial Installation of Sand	
<b>9 SAFE OPERATING GUIDELINES</b>	<b>24</b>
A Operation	
B Lighting the HEATMOR™ for the First Time	
C Dew Point	
D Loading Coal into the HEATMOR™	
E What Should I Burn?	
F Types of Coal	
G Handling and Storage of Coal	
H Loading Coal into the HEATMOR™	
<b>10 HEAT TRANSFER FLUID (HTF)</b>	<b>31</b>
A Qualities of Water to Use	
B Heat Transfer Fluid (HTF) Level Maintenance	
C Removal /Replacement of System Heat Transfer Fluid	
D Freeze Protection	
E Adding Freeze Protection Products	

<b>11 BLADDER ASSEMBLY</b>	<b>33</b>
A Bladder	
B Removal and Replacement of the Bladder	
C Bladder Ball Valve and Bladder Hose	
D Heat Transfer Fluid (HTF) Level Gauge	
E Fluid Level Sensor	
F Bladder Cover Plate	
<b>12 WATER JACKET</b>	<b>36</b>
A Supply Line and Return Line Threaded Connectors	
B Relief Vent Pipe with Elbow	
<b>13 FIREBOX AND OTHER COMPONENTS</b>	<b>37</b>
A Firebox	
B Firebox Door	
C Firebox Door Hoses and Elbows	
D Firebox Door Handle	
E Firebox Door Hinge	
F Firebox Door Latch	
G Firebox Door Magnet	
H Firebox Door Gasket	
I Firebox Door Frame	
J Firebox / Base Connector Clamps	
K Firebrick	
L Standard Grates	
M Optional Shaker Grates	
N Sand	
O Flash Curtain / Heat Shield	
<b>14 AIR SUPPLY</b>	<b>48</b>
A Combustion Air Blower and Flipper Assembly	
B Air Box(s)	
C Combustion Air Tube	
D Automatic Fan Switch (A.F.S.)	
<b>15 CHIMNEY AND FLUE</b>	<b>51</b>
A Chimney	
B Chimney Extension(s)	
C Rain Caps and Spark Arrestor	
D Creosote	
E Flue	
F Flue Cover	
G Flue Scraper	

<b>16 ASHES</b>	<b>53</b>
A Ash Management and Ash Removal	
B Ash Pan	
C Ash Auger	
D Ash Auger Tube	
E Ash Auger Tube Cover Plate	
<b>17 ELECTRONIC AQUASTAT CONTROLLER</b>	<b>56</b>
<b>18 ELECTRICAL</b>	<b>57</b>
A Electrical Supply	
B Electrical Supply Junction Box	
C Double Electrical Outlets at Rear	
D High Temperature Safety Shutoff	
E Front Light and Fan Power Switch	
F In the Event of a Power Failure	
<b>19 EXTERIOR CLADDING AND INSULATION</b>	<b>60</b>
A Outer Front Door of HEATMOR™	
B Roof of the HEATMOR™	
C Sides of the HEATMOR™	
D Insulation	
<b>20 CHECKING FOR AIR LEAKS</b>	<b>62</b>
<b>21 HEAT TRANSFER FLUID (HTF) LEAKS</b>	<b>63</b>
<b>22 DOMESTIC COIL</b>	<b>64</b>
<b>23 MAINTENANCE CHECKLIST</b>	<b>65</b>
A Season Start-Up	
B End of Season	
<b>24 FREQUENTLY ASKED QUESTIONS</b>	<b>67</b>
<b>25 TROUBLESHOOTING AND SOLUTIONS</b>	<b>69</b>
<b>HEATMOR™ STAINLESS STEEL LIMITED WARRANTY</b>	<b>77</b>
<b>HOW TO MAINTAIN YOUR WARRANTY</b>	<b>78</b>
<b>HEATMOR REFERRAL</b>	<b>79</b>
<b>NOTES</b>	

## NOTICE TO THE READER

HEATMOR™ warrants and guarantees ALL HEATMOR™ Stainless Steel Outdoor Furnace Models. HEATMOR™ does not warrant or guarantee any of the supporting products described within this Operations and Maintenance Manual.

The contents, descriptions, directions, diagrams, and recommendations within this material are for the sole purpose of suggested operation and maintenance methods.

Furthermore, HEATMOR™ shall not be liable for any special, consequential, or exemplary damages, resulting, in whole or part, from the readers' neglectful use, based upon the material within this Operations and Maintenance Manual. Adhere to and follow all maintenance procedures set forth in this manual.

The methods of operation described within this Operations and Maintenance Manual have proven to be effective for HEATMOR™ for the sole purpose of the operation of a HEATMOR™ Stainless Steel Outdoor Furnace.

All formulas and figures listed within this Operations and Maintenance Manual are approximated and should be read as such.

For additional copies or information, contact  
HEATMOR™  
105 Industrial Park Court NE,  
P.O. Box 787,  
Warroad, MN 56763 USA  
Phone: (218) 386-2769  
Fax: (218) 386-2947  
Website: [www.heatmor.com](http://www.heatmor.com)  
E-mail: [woodheat@heatmor.com](mailto:woodheat@heatmor.com)

Copyright © 2013- HEATMOR™

All rights reserved. No part of this Operations and Maintenance Manual may be reproduced or used in any form or by any means - graphic, electronic or mechanical, including photocopying, recording, taping, or information storage and retrieval systems - without the written permission of HEATMOR™.

MODELS (100 CB, 200 CB, 400 CB)

Supplemental literature will be provided in addition to this manual for Models 200 OB and 400 OB.

Units are Safety Listed by Omni Test Laboratories

Report # 275-O-11-4 and # 275-O-12-4

Listed to UL2523-2009 and CSA B366.1-11



The use of wood in these appliances, except for coal ignition purposes is prohibited by law.

### HEATMOR™ STAINLESS STEEL OUTDOOR FURNACE MODELS



Model 100 CB



Model 200 CB



Model 400 CB

### RESIDENTIAL FURNACE SPECIFICATIONS

Specifications	Model 100 CB	Model 200 CB	Model 400 CB
Overall Width (Inches)	50	50	50
Base Width (Inches) (Footprint)	46.5	46.5	46.5
Overall Height (Inches) (With chimney stub)	82.5	82.5	82.5
Overall Length (Inches)	65	77	95
Base Length (Inches) (Footprint)	53.75	65.75	83.75
Total Weight (lbs., without HTF)	1375	1599	1968
HTF Capacity (U.S. gallons)	90	123	172
Forced Draft (C.F.M.)	75	150	2 x 150 = 300
Chimney Size (Inches)	8	8	8
Insulated Heating Area (Sq. Ft.)*			
1 Loading/day	1500	2500	5000
2 Loading/day	3000	5000	10,000
Firebox Width (Inches)	28	28	28
Firebox Length (Inches)	24	36	54
Firebox Height (Inches)	36	36	36
Volume of Firebox (Cu. Ft.)	14	21	32
Firebox Door Size (Inches) (W x H)	20 x 18	20 x 18	20 x 18
Flue Transfer Area (Sq. Ft.)	6.5	10	15
BTU's (maximum)**	100,000	200,000	400,000
Water Jacket Steel Gauge	409 Stainless 10	409 Stainless 10	409 Stainless 10
Firebox Steel Gauge	409 Stainless 10	409 Stainless 10	409 Stainless 10
Base Steel Gauge	409 Stainless 14	409 Stainless 14	409 Stainless 14
Base of Unit to Bottom of Loading Door (Inches)	24	24	24
Warranty - Workmanship	Limited Lifetime	Limited Lifetime	Limited Lifetime
Warranty - Corrosion	Limited Lifetime	Limited Lifetime	Limited Lifetime
Approvals Test Standards	UL 2523-2009 CSA-B366.1-11	UL 2523-2009 CSA-B366.1-11	UL 2523-2009 CSA-B366.1-11
Hook-ups	Back	Back	Back
Total Heat Extraction Area (Sq. Ft.)	30.89	40.89	55.89
Type of Fuel	Coal Only	Coal Only	Coal Only
Electrical Supply	115 V, 60HZ, 1 Phase	115 V, 60HZ, 1 Phase	115 V, 60HZ, 1 Phase

\* This is an estimate only. Actual loadings per day may vary depending on structures heated and type of coal used.

\*\* This value should only be used as an indication of the furnace's heat recovery ability. Sustained outputs at this rate will increase the loadings per day. Some types of coal may prevent the furnace from reaching this maximum output.

### FRONT CUT-AWAY VIEW OF HEATMOR™ OUTDOOR FURNACE

(For parts not shown on the cut-away view, please refer to the appropriate chapter for further details.)

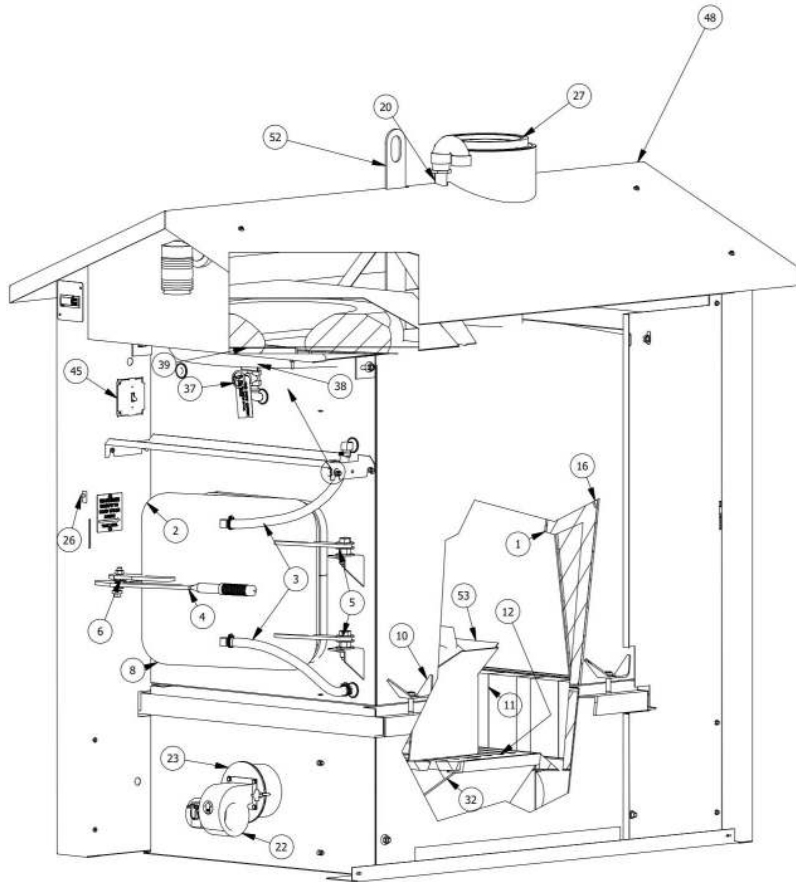

### FURNACE PARTS LIST

#### Firebox

- 1) Firebox
- 2) Firebox door
- 3) Firebox door hoses and elbows
- 4) Firebox door handle
- 5) Firebox door hinge
- 6) Firebox door latch
- 7) Firebox door handle holder (not shown)
- 8) Firebox door gasket
- 9) Firebox door frame
- 10) Firebox / base connector clamps
- 11) Firebrick
- 12) Standard grates
- 13) Optional shaker grates (not shown)
- 14) Sand (not shown)
- 15) Flash curtain / heat shield (next page)

#### Water jacket

- 16) Water jacket (surrounds firebox)
- 18) Supply / Return Valve (next page)
- 19) Return line threaded connector (next page)
- 20) Relief vent pipe

#### Air supply

- 22) Combustion air blower (400 CB - 2 Fans)
- 23) Flipper assembly
- 24) Air box(s)(next page)
- 25) Combustion air percentage tube (next page)
- 26) Automatic Fan Switch (A.F.S.)

#### Chimney and top flue

- 27) Chimney Stub
- 28) Chimney extension(s) (not shown)
- 29) Rectangular flue (next page)
- 30) Flue cover plate (next page)
- 31) Flue scraper (not shown)

#### Ashes

- 32) Ash pan
- 33) Ash auger (not shown)
- 34) Ash auger tube
- 35) Ash auger tube cover plate

#### Bladder assembly

- 36) Bladder
- 37) Bladder gate valve and hose
- 38) Fluid level gauge
- 39) Bladder inspection cover plate

#### Electrical

- 41) Electrical supply junction box
- 42) Electrical plug outlets
- 43) High Temperature Safety Shutoff
- 44) Electronic Auquastat Controller
- 45) Front light and combustion air blower control switch

#### Housing

- 46) Outer front door (not shown)
- 47) Outer rear door (not shown)
- 48) Roof
- 49) Sides (not shown)
- 50) Insulation (not shown)

#### Optional hot water internal coil

- 51) Internal coil (not shown)

#### Lift hook

- 52) Lift ring
- 53) Light Globe, Keys, Manual

### REAR CUT-AWAY VIEW OF HEATMOR™ OUTDOOR FURNACE

(For parts not shown on the cut-away view, please refer to the appropriate chapter for further details.)

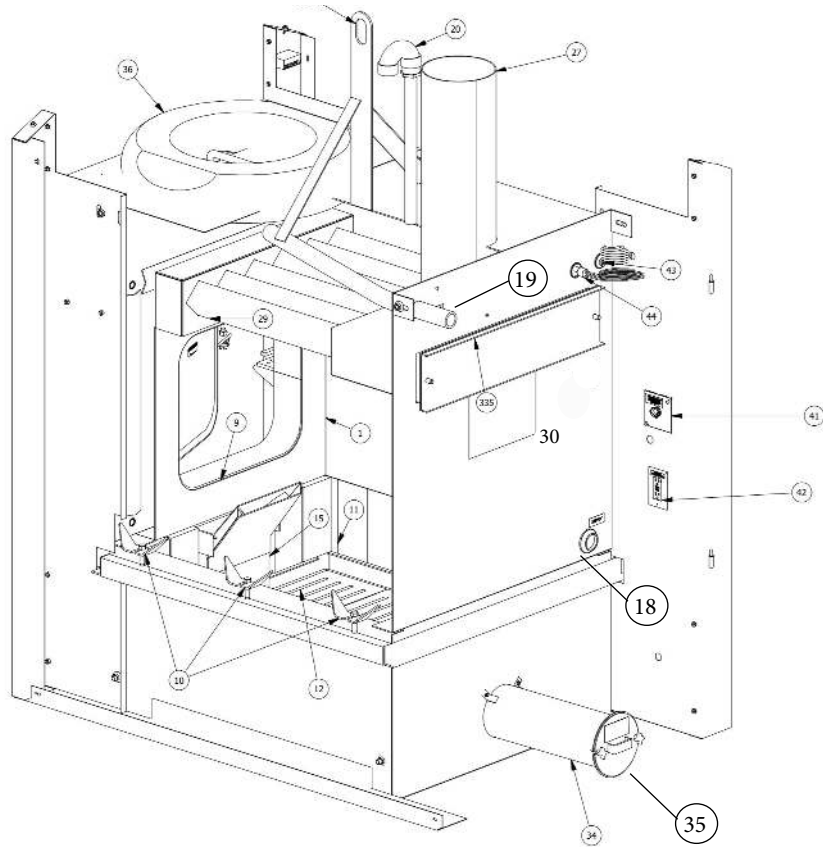

### FURNACE PARTS LIST

#### Firebox

- 1) Firebox
- 2) Firebox door
- 3) Firebox door hoses and elbows
- 4) Firebox door handle
- 5) Firebox door hinge
- 6) Firebox door latch
- 7) Firebox door handle holder (not shown)
- 8) Firebox door gasket
- 9) Firebox door frame
- 10) Firebox / base connector clamps
- 11) Firebrick
- 12) Standard grates
- 13) Optional shaker grates (not shown)
- 14) Sand (not shown)
- 15) Flash curtain / heat shield

#### Water jacket

- 16) Water jacket (surrounds firebox)
- 18) Supply / Return Valve
- 19) Return line threaded connector
- 20) Relief vent pipe

#### Air supply

- 22) Combustion air blower (400 CB - 2 Fans)
- 23) Flipper assembly
- 24) Air box(s)
- 25) Combustion air percentage tube
- 26) Automatic Fan Switch (A.F.S.)

#### Chimney and top flue

- 27) Chimney Stub
- 28) Chimney extension(s)(not shown)
- 29) Rectangular flue
- 30) Flue cover plate
- 31) Flue scraper(not shown)

#### Ashes

- 32) Ash pan
- 33) Ash auger (not shown)
- 34) Ash auger tube
- 35) Ash auger tube cover plate

#### Bladder assembly

- 36) Bladder
- 37) Bladder gate valve and hose
- 38) Fluid level gauge
- 39) Bladder inspection cover plate

#### Electrical

- 41) Electrical supply junction box
- 42) Electrical plug outlets
- 43) High Temperature Safety Shutoff
- 44) Electronic Auquastat Controller
- 45) Front light and combustion air blower control switch

#### Housing

- 46) Outer front door (not shown)
- 47) Outer rear door (not shown)
- 48) Roof
- 49) Sides (not shown)
- 50) Insulation (not shown)

#### Optional hot water internal coil

- 51) Internal coil (not shown)

#### Lift hook

- 52) Lift ring
- 53) Light Globe, Keys, Manual

### MINIMUM CLEARANCE SEPARATION SPECIFICATIONS

The HEATMOR™ furnace, is certified to be installed outside, away from other buildings. Please observe the following “Clearance to Combustibles” guidelines. If you have any further questions, which are not addressed in this Operators Manual, please contact your local dealer for further information.

- ◆ To HEATMOR™ Stainless Steel Outdoor Furnace **Back.**           **96 Inches**
- ◆ To HEATMOR™ Stainless Steel Outdoor Furnace **Top.**           **18 Inches**
- ◆ To HEATMOR™ Stainless Steel Outdoor Furnace **Front.**       **48 Inches**
- ◆ To HEATMOR™ Stainless Steel Outdoor Furnace **Chimney.**   **96 Inches**
- ◆ To HEATMOR™ Stainless Steel Outdoor Furnace **Sides.**       **6 Inches**
- ◆ **Do not** store combustible liquids or materials near the furnace.
- ◆ It is not recommended to install the furnace in any form of building.

Before installing your HEATMOR™ Stainless Steel Outdoor Furnace, if in the **United States**, always check any and all applicable state and local regulations and inform your insurance agent.

Before installing your HEATMOR™ Stainless Steel Outdoor Furnace, if in **Canada**, always check any and all applicable Provincial and Municipal regulations and inform your insurance agent.

HEATMOR™ strongly recommends not installing a HEATMOR™ Stainless Steel Outdoor Furnace within 50 feet of any flammable structure.

A HEATMOR™ Stainless Steel Outdoor Furnace should be located with consideration to your neighbor’s property and in accordance with local ordinances.

HEATMOR™ Outdoor Furnaces, Model 100 CB, 200 CB and 400 CB are not designed or certified to be located in densely populated areas.

### WARNINGS AND PRECAUTIONS

**Please read the following list of cautions, warnings and dangers before installing and operating your HEATMOR™ STAINLESS STEEL OUTDOOR FURNACE. If you have any questions or concerns regarding any of the following cautions, warnings, dangers or instructions in this Operations and Maintenance manual, please contact your local dealer.**

#### Installation

Installation should be performed by a qualified installer and will comply with all the requirements of the authority having jurisdiction over the installation.

- 1) The HEATMOR™ furnace is designed for outside installations, away from other buildings.
- 2) Please observe the following “Clearance to Combustibles “ guidelines.  

To unit back = 96 inches	To unit sides = 6 inches
To unit front = 48 inches	To chimney = 96 inches
To unit top = 18 inches	
- 3) Before installing the furnace, always check any and all applicable provincial and local regulations.
- 4) A HEATMOR™ Stainless Steel Outdoor Furnace should be located with consideration to your neighbor’s property and in accordance with local ordinances. HEATMOR™ Outdoor Furnaces, Model 100 CB, 200 CB and Model 400 CB, are not designed to be located in densely populated areas.
- 5) HEATMOR™ suggests the use of brass fittings when installing the unit.
- 6) Before installing the HEATMOR™ furnace, contact and inform your insurance agent.
- 7) The HEATMOR™ Outdoor Furnace is to be installed on a concrete base only. Any attempt to place the furnace on any other surface may void the warranty.
- 8) Do not connect the HEATMOR™ furnace to the chimney of any existing heating system.
- 9) This unit was not designed, nor is it recommended, for use as a stand-alone heating system. A back up source of heat must be in place to prevent the outdoor furnace from freezing and to provide supplementary heat for the heated buildings.
- 10) Do not pressurize the HEATMOR™ Outdoor Furnace. This unit is designed to operate under atmospheric pressure only.
- 11) Place the in-line fill/drain assembly in a location where the drained contents of the HEATMOR™ will not cause damage to the surrounding areas or it’s contents.





## Electrical

- 1) Do not connect the electrical components of the HEATMOR™ Outdoor Furnace to any other electrical appliance.
- 2) This HEATMOR™ Outdoor Furnace operates on 115-volt power only. Do not connect the furnace to a 220-volt electrical supply.
- 3) **HEATMOR™ recommends a licensed professional electrician make all the necessary electrical connections involved with the installation of the furnace.**
- 4) Always disconnect the HEATMOR™ Outdoor Furnace from the main electrical supply before servicing any of the electrical components of the HEATMOR™ Outdoor Furnace.
- 5) Always disconnect any existing electrical connections to any in-house heating system, before installing the outdoor furnace to any existing indoor heating system or appliances.
- 6) The red wire from the New Style High-Limit on the back of the HEATMOR™ should be wired to the indoor temperature control to override the thermostat. This will dissipate excess heat in the event of a possible malfunction with the HEATMOR™ (The red wire is capped off in the electrical junction box when the HEATMOR™ is new.)

## Other

The unit may be connected to an existing indoor boiler system by installing a water-to-water heat exchanger.



- 1) HEATMOR™ recommends that you contact a licensed professional plumber to make all necessary plumbing installations between the HEATMOR™ furnace and the existing heating system of your building(s).
- 2) Do not operate the HEATMOR™ furnace until all electrical and water line connections have been properly installed and tested.
- 3) Do not allow any fire in the firebox until the HEATMOR™ has the correct amount of Heat Transfer Fluid (HTF) and sand installed.
- 4) Absolutely no fire in the firebox when performing any repair. Do not perform this repair when unit HTF temperature is unsafe. Always wear proper personal protective equipment when working with HTF and chemicals.

### MODEL 100 PAD SPECIFICATIONS

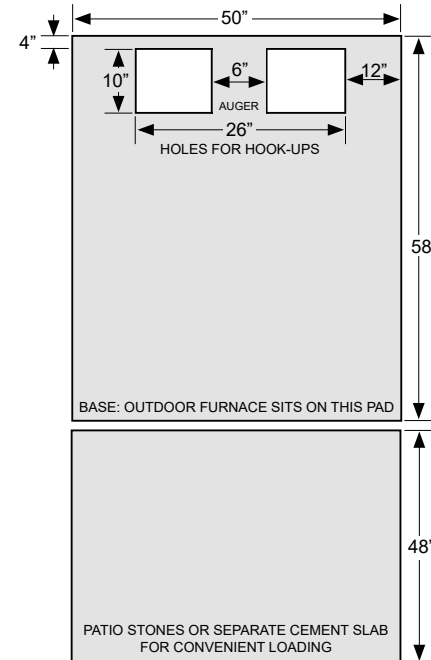

The actual pad size is 50" x 58". This gives approximately 2" extra on all sides of furnace. CAUTION: Do not exceed this length measurement. Width can be wider if desired.

The bottom of the loading door is 24" above ground or base of furnace. If you desire to have the loading door higher, you can do so by making the pad depth thicker. Example: 12" instead of 4" or any figure in between.

Patio stones or separate cement pad in front of the loading door should **NOT** be attached to main base of furnace.

It is recommended to use steel mesh or R-bar in pad for strength.

#### Benefits to raising the pad:

1. Gives space below the ash auger to place a pail for convenient ash removal.
2. Allows better visibility of the firebox.
3. Less bending when adding coal.
4. Keeps smoke above the operator.
5. Protects the base of the HEATMOR™.

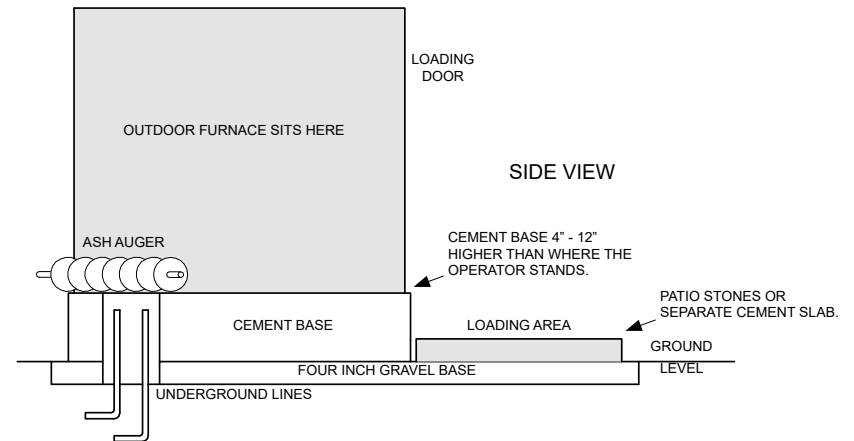

## MODEL 200 PAD SPECIFICATIONS

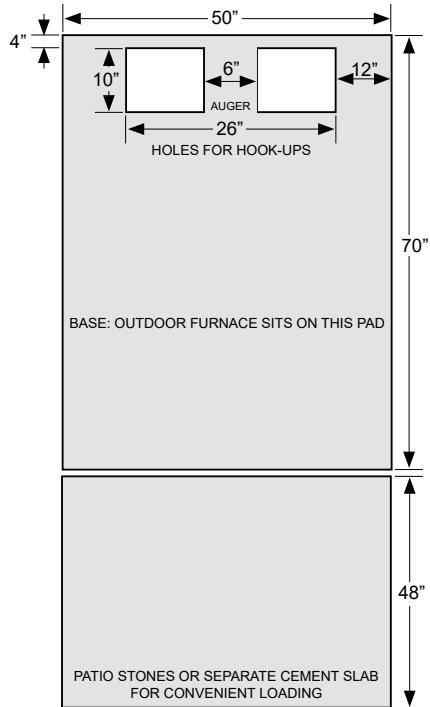

The actual pad size is 50" x 70". This gives approximately 2" extra on all sides of furnace. CAUTION: Do not exceed this length measurement. Width can be wider if desired.

The bottom of the loading door is 24" above ground or base of furnace. If you desire to have the loading door higher, you can do so by making the pad depth thicker. Example: 12" instead of 4" or any figure in between.

Patio stones or separate cement pad in front of the loading door should **NOT** be attached to main base of furnace.

It is recommended to use steel mesh or R-bar in pad for strength.

### Benefits to raising the pad:

1. Gives space below the ash auger to place a pail for convenient ash removal.
2. Allows better visibility of the firebox.
3. Less bending when adding coal.
4. Keeps smoke above the operator.
5. Protects the base of the HEATMOR™.

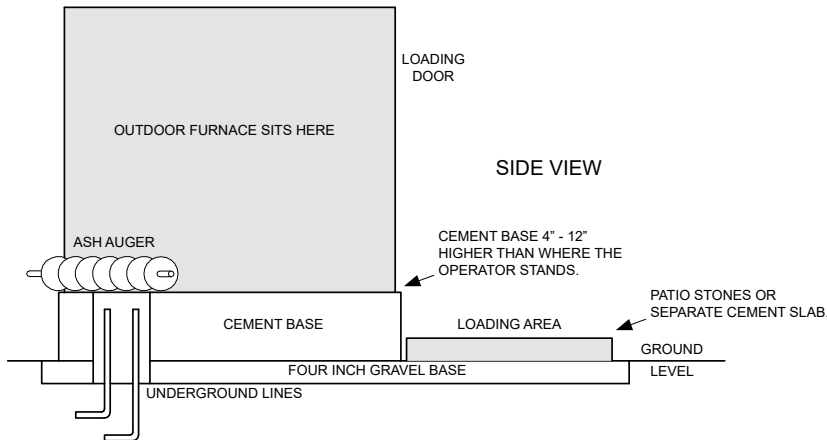

SIDE VIEW

## MODEL 400 PAD SPECIFICATIONS

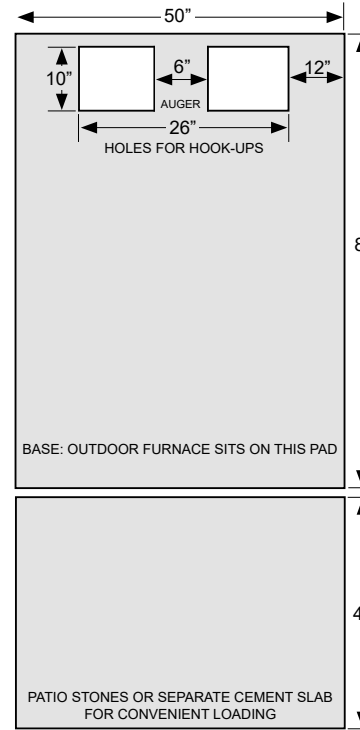

The actual pad size is 50" x 88". This gives approximately 2" extra on all sides of furnace. CAUTION: Do not exceed this length measurement. Width can be wider if desired.

The bottom of the loading door is 24" above ground or base of furnace. If you desire to have the loading door higher, you can do so by making the pad depth thicker. Example: 12" instead of 4" or any figure in between.

Patio stones or separate cement pad in front of the loading door should **NOT** be attached to main base of furnace.

It is recommended to use steel mesh or R-bar in pad for strength.

### Benefits to raising the pad:

1. Gives space below the ash auger to place a pail for convenient ash removal.
2. Allows better visibility of the firebox.
3. Less bending when adding coal.
4. Keeps smoke above the operator.
5. Protects the base of the HEATMOR™.

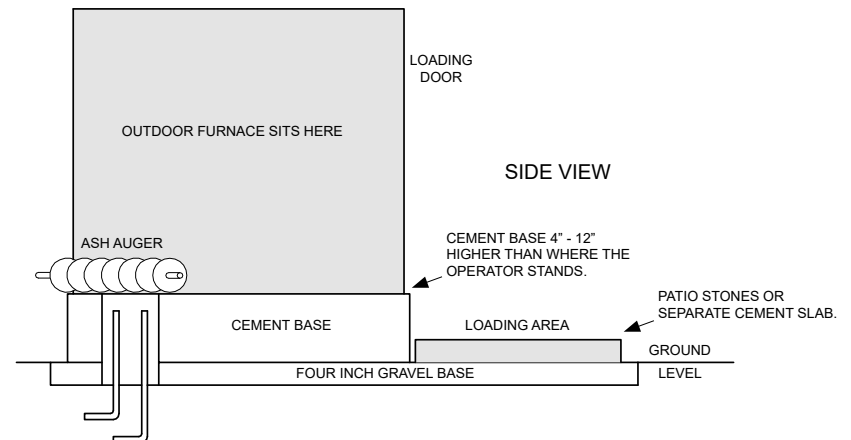

SIDE VIEW

### INSTALLATION OF THE HEATMOR™ FURNACE

Installation should be performed by a qualified installer and will comply with all the requirements of the authority having jurisdiction over the installation.

#### Principles

- 1) Need to have an airtight seal between the concrete base and the perimeter of the firebox base.
- 2) Need to seal the perimeter of the entire HEATMOR™ so rodents are not able to find a home inside the HEATMOR™.
- 3) Need to lift the HEATMOR™ without damaging it.

#### Equipment Required

- 1) It is **not** possible to lift a HEATMOR™ with the forks of a forklift under the HEATMOR™. It **must be lifted from the top**, by the lifting hook. A crane or heavy backhoe works best, although a heavy duty farm tractor is acceptable.
  - A) With a farm tractor, extreme care must be taken to prevent the HEATMOR™ from swinging and causing damage to the HEATMOR™.



Lift Hook

#### Placing the HEATMOR™ on the Concrete Base

- 2) Before setting the HEATMOR™ onto the concrete base, it is a good idea to place a solid sheet of the proper "reflective air foil" (also called bubble foil) between the concrete and the HEATMOR™. This will absorb ridges in the concrete and make it easier to apply caulking around the inside perimeter of the base of the HEATMOR™. This reflective foil will also reflect escaping heat up into the sand, and help prevent air leaks into the firebox if cement cracks.
- 3) Make sure the total area of the base (where the sand is going) is on solid concrete. Do not let the base extend past the hole in the concrete where the lines come in.
- 4) After the HEATMOR™ is in place perform the following:

#### Caulking around the Firebox Base

- A) One person should get into the HEATMOR™.
- B) Apply a substantial bead of caulking around the entire inside perimeter of the base. This will give an airtight seal so no air will seep through the sand. This should require about three tubes of High Temperature Silicone.

#### Caulking around the Outside Perimeter of HEATMOR™

- C) With a sharp knife, trim any excess bubble foil that extends past the base of the HEATMOR™.
  - D) Apply a bead of caulking around the entire outside
- 5) Remove transport plugs from relief vent on the roof of your furnace, supply ball valve, and return pipe on the back of your furnace. (3 different plugs)
  - 6) Close supply valve located on the back of your furnace.



Supply Valve (closed)

### Filling the HEATMOR™ Outdoor Furnace Initially with Water

Before filling your HEATMOR™ furnace with water, make sure the water you intend to use has been tested and approved. The unit comes prefilled with concentrated DOWFROST™ HD corrosion inhibited propylene glycol. DOWFROST™ HD **MUST BE DILUTED WITH APPROVED WATER**. Heatmor highly recommends the use of Pure Water, such as: Reverse Osmosis, Deionized, or Distilled.

#### \*APPROVED WATER MUST MEET THE REQUIREMENTS OF:

**PH LEVEL OF 7.0 TO 11.5**

**CHLORIDE LEVEL OF UNDER 50**

**HARDNESS UNDER 200 PPM**

**SOFTENED AND FILTERED TO LIMIT THE AMOUNT OF SOLIDS.**

*All plumbing connections at the back of the HEATMOR™ furnace, all electrical hookups, and all heating appliances should be installed and tested for possible leaks. HEATMOR™ suggests the use of brass fittings when installing the unit.*

*When filling or adding fluid to your HEATMOR™ always be sure to maintain a minimum of 40% DOWFROST™ HD (corrosion inhibited-propylene glycol) in with your approved water.*

*If you have any questions regarding installation of the furnace or any aspect of installation, contact your local dealer.*



**Never start a fire inside the firebox until the water jacket is full of HTF, and sand has been added to the base to the correct level.**

- 1) Close the bladder ball valve located at the front of the HEATMOR™ furnace. This valve will ensure no air can enter the bladder.
- 2) Close the bottom supply line valve at the back of the HEATMOR™.
- 3) Open the top return line valve at the back of the HEATMOR™.
- 4) Connect the water source to the fill/drain valve located on the supply fitting and open it
- 5) Turn on the source of water.
- 6) The pressured water will now flow through and remove the air out of the lines and exchangers as the water flows into the HEATMOR™.
- 7) Continue adding water until water is level with the relief vent pipe. Be careful to minimize overflow.
- 8) Turn off the source of water.



Rear of Furnace

**The HEATMOR™ is now full of water and at least 40% DOWFROST™ HD which means it is now Heat Transfer Fluid (HTF).**

- 9) Close the drain/fill valve and replace the safety cap.
- 10) Open the supply valve.
- 11) Open the bladder valve.

**NOTE:** The circulator pumps cannot "push" much air through a system. They are designed to move Heat Transfer Fluid (HTF) not air.

- 12) Start the circulating pump. Remember to properly bleed air from the pump.

**ABSOLUTELY NO FIRE IN THE FIREBOX WHEN PERFORMING THIS PROCESS. DO NOT PERFORM THIS PROCESS WHEN UNIT HTF TEMPERATURE IS UNSAFE. ALWAYS WEAR PROPER PERSONAL PROTECTIVE EQUIPMENT WHEN WORKING WITH HTF AND CHEMICALS.**

NOTE: Before the furnace is fired up, the furnace is filled with Heat Transfer Fluid (HTF). While the furnace is filling with water, the bladder is shut off to prevent air from entering the bladder. When the furnace is freshly filled the HTF temperature is approximately 50 degrees Fahrenheit. When the furnace is full of HTF you will notice HTF coming out onto the roof from the relief vent pipe. At this point the water should be turned off and the bladder valve opened. After the furnace is fired up, the HTF temperature will start to increase. While the HTF temperature rises, the water will expand as it heats up, causing the excess HTF to go into the bladder. It will go into the bladder because it is the place of least restriction. This is another reason why we do not fill the bladder initially, too much HTF in the bladder at cooler temperatures could cause the bladder to overflow at higher temperatures caused by the expansion of the HTF during temperature rise

### Maintaining Heat Transfer Fluid HTF in the Bladder and HEATMOR™

- 1) Keep your bladder valve closed when filling your stove with HTF (approved water and at least 40% DOWFROST™ HD) but open at all other times. Your bladder should have a small amount of HTF in it.
- 2) HEATMOR™ does not recommend the use of in-line fill valves due to the dilution of the HTF over time.

### Low Heat Transfer Fluid (HTF) Condition

If the HTF level is below the bladder port when the HTF heats up, air will enter the bladder instead of HTF. To remove the air from the bladder, follow the steps below:

- 1) Close the bladder ball valve.
- 2) CAREFULLY remove the bladder hose, allowing the bladder to empty its contents.
- 3) After bladder is empty of air/HTF, re-attach the bladder hose to the bladder ball valve and tighten the hose clamp.
- 4) Connect the water source to the return line leading to the HEATMOR™. Use a garden hose to add the water to the return line.
- 5) Refer to **Filling the HEATMOR™ Outdoor Furnace Initially with Heat Transfer fluid**

**INSTALLATION SHOULD BE PERFORMED BY A QUALIFIED INSTALLER AND WILL COMPLY WITH ALL THE REQUIREMENTS OF THE AUTHORITY HAVING JURISDICTION OVER THE INSTALLATION.**

**READ THROUGH THE ENTIRE OPERATIONS AND MAINTENANCE MANUAL BEFORE OPERATING YOUR HEATMOR STAINLESS STEEL OUTDOOR FURNACE**

### Initial Installation of Sand

#### *Types of sand to use*

- 1) Sand that does not contain clay, rocks or organic matter is appropriate. **Use a sand that when packed will not allow air to pass through.** Mortar sand, or sand that is used in the redi-mix concrete business is good. Never use gravel.
- 2) Model 100 furnaces require approximately 0.18 cubic yards, Model 200 – 0.25 cubic yards, and Model 400 – 0.38 cubic yards of sand.

#### *Installation*

- 1) Cover the grates with a piece of cardboard.
- 2) One person enters the firebox.
- 3) Another person shovels the sand into the firebox while the person inside packs the sand completely, using a piece of wood that is about 2 x 4 x 10 inches long.
- 4) Fill the base with sand, level to the top of the grates.



Stove without Sand



Stove with Sand



**NEVER LIGHT A FIRE INSIDE THE FIREBOX UNTIL THE WATER JACKET IS FULL OF WATER AND SAND HAS BEEN ADDED TO THE CORRECT LEVEL IN THE BASE.**

### SAFE FURNACE OPERATION GUIDELINES

#### Operation

Heatmor™ outdoor furnaces, model 100 CB, 200 CB, and 400 CB are certified to burn coal only. Refer to **WHAT SHOULD I BURN**.



Burning of other materials may result in serious burns, health consequences, or damage to this furnace and other components of the heating system and may void warranty.

#### \*\*\*IMPORTANT NOTICE\*\*\*

Refer to [Loading Coal Into The Heatmor™](#), for additional safe loading procedures.



- 1) Never open the firebox door if the combustion air blower is operating or if you suspect a roaring hot fire inside the firebox.
- 2) Never open firebox door immediately after the combustion air blowers have shut off. If the HTF temperature is very close to the high setting, you should assume the air combustion fans have just shut off.
- 3) If there is more than a "wiff" of smoke coming from the chimney and the draft fan is off, do not open the firebox door for at least 30-45 seconds. The burn cycle would have just ended and the firebox will be full of unburned gases (smoke) that may ignite when fresh air is introduced.
- 4) Load the unit with coal carefully, but quickly. After loading coal make sure all debris is cleaned from the firebox doorframe and gasket. Then close firebox door securely.
- 5) Keep the firebox door, ash auger tube cover cap, top flue cover plate, and the outer door of the HEATMOR™ furnace closed at all times except for servicing and refueling.
- 6) Keep the locking handle on the outer door locked at all times when not servicing or refueling to reduce the risk of tampering and possible injury.
- 7) Never add HTF to the HEATMOR™ furnace if the internal HTF temperature is over 212 degrees Fahrenheit. Failure to adhere to this warning may cause a steam flash and result in an explosion.

- 8) Do not store combustible liquids or materials near the outdoor furnace. Adhere to the "Clearance to Combustibles" guidelines.
- 9) Never use gasoline, kerosene, charcoal, lighter fluid or similar liquids to start, re-start or freshen up a fire. Using such liquids may result in severe burns and injury.
- 10) When adding HTF, DOWFROST™ HD or maintaining the HEATMOR™ furnace, protective clothing must be worn at all times.
- 11) **Never** leave the HEATMOR™ furnace unattended while the firebox door is open or unlatched.
- 12) **Stay clear of any smoke emitting from the firebox.**
- 13) **Do not** burn garbage, tires, solvents, engine oil, gasoline, or other inappropriate materials.
- 14) Store ashes outside, in a metal container with a metal tight fitting lid, away from the outdoor furnace and other buildings. No other waste should be placed in this container.
- 15) Wear a particle mask when removing ashes.
- 16) Ash auger may be hot after removing ashes.
- 17) In case of power failure, do not open any doors on the HEATMOR™. Monitor the HTF temperature very closely. Refer to "freeze protection" in this manual.
- 18) In below freezing weather, if the HTF temperature in the HEATMOR™ drops below 40 degrees Fahrenheit, confirm there is at least 40% DOWNFROST™ HD in with your water
- 19) Check daily for creosote buildup until experience shows how often cleaning is necessary.
- 20) Be aware that weekly cleanings can be necessary in mild weather, even though monthly cleanings can be enough in the coldest months due to more creosote being deposited when there are fewer burn cycles.

## Lighting the HEATMOR™ for the First Time

When lighting the HEATMOR™ furnace for the first time, all installations must be complete and the furnace must be full of Heat Transfer Fluid (HTF). Use the following steps simply as a guideline or contact your local dealer for further instruction. **Read the entire manual before lighting, so you have a complete working knowledge of the furnace. Ask for a demonstration from your local dealer. It is very important to fully educate all persons who will be lighting and fueling the HEATMOR™ furnace.**

- 1) **Confirm the furnace is full of HTF**
- 2) Open bladder valve.
- 3) Confirm there is 115-volt electrical power supplying the HEATMOR™ furnace.
- 4) Place some small pieces of wood (five pounds) with paper into the firebox.
- 5) Place a few larger pieces of wood (20 pounds) on top of the smaller pieces.
- 6) Light the fire.
- 7) Leave the fire box door partially open to allow the fire to start burning. The firebox door should only need to be open about two inches. At this point the smoke should go up the chimney and not out the firebox door.
- 8) Once the fire is burning rather briskly, close the fire box door and turn off the light switch which in turn will make the combustion air blower(s) operate.
- 9) Operate the blowers for approximately 10 minutes.
- 10) Turn off the blowers. Wait a few seconds to allow the combustion to decrease.
- 11) Open the firebox door and add a substantial amount of coal to the firebox.
- 12) Turn on the blowers.
- 13) Securely close the firebox door and outer door.
- 14) The use of wood in these appliances, except for coal ignition purposes, is prohibited by law.

## Dew Point

**NOTE:** As the temperature inside of the firebox is increasing, there will be some sweating inside the firebox. There may be streams of moisture running down the inside firebox walls and down the inside of the firebox door. Moisture may run out onto the fan cover, below the firebox door, and even out the auger tube. **THE HEATMOR™ IS NOT LEAKING!**

Just as moisture collects on the inside of a **warm** house window on a **cold** outside day, the same thing is occurring inside the HEATMOR firebox. The **warm** moisture in the smoke is condensing on the **cold** firebox walls of the HEATMOR. In most typical situations, once the HTF temperature is above approximately 130 degrees Fahrenheit, the sweating will stop because you are above the **dew point**.

## Loading Coal into the HEATMOR™

It is very important to fully educate all those who will be loading the furnace with coal.

Loading a large amount of coal into the HEATMOR™ furnace once a day **is not always best**. We have found that you have a more efficient fire and produce less smoke when you add fuel twice a day. **Example:** Half of the days' demand in the morning and half in the evening. The number of loadings and the amount of coal needed will vary depending on the amount of heat being removed.

*Here are some suggested points to assist you in loading your furnace.*

- 1) Make sure you have your fuel readily available to fill your furnace. (i.e. a wheelbarrow full of coal **near** the furnace)
- 2) Maintain a clear, clean area in front of the furnace.
- 3) Open the outer front door. This allows you access to the inner firebox door as well as opens the anti-rollout device. This allows air into the firebox to decrease the possibility of the exhaust igniting and creating a "flash back" before you open the main firebox door.
- 4) Turn on the light switch. The light should turn on and the combustion air blowers should turn off if they were operating correctly.
- 5) Standing to the right, next to the exterior door, **with your left hand and your left arm outstretched**, move the fire box door handle out of the safety latch.
- 6) Crack the firebox door open about two inches and allow any pressure left over in the firebox to escape.
- 7) Open the firebox door as you step backwards towards the exterior door. This allows you to be out of the way if there is a "flash back" or exhaust exiting the door opening.
- 8) Set the firebox door handle into the holder provided on the outer door.
- 9) After all exhaust has been eliminated, give the ashes over the grates a light stirring with a long rake.
- 10) Add the necessary fuel to the firebox, being careful not to push ashes into the air boxes.
- 11) Close the firebox door and latch securely.
- 12) Turn off the light switch. This will return power to the blowers and turn off the light.
- 13) Close and lock the exterior door.

## What Should I Burn?

This furnace is designed to burn coal.

Types of coal allowed to be used include: Pennsylvania anthracite, Eastern Canadian Bituminous and Western Canadian Sub-bituminous.

Learn to load the furnace to most appropriately match the heat demand. Warmer outdoor temperatures indicate a need for smaller loads, thereby matching demand to supply and resulting in higher efficiencies. Being aware that your individual "Types of Coal" will aid in your decisions.

### *How does a fire burn out?*

When the temperature of the HTF has reached its high limit (185 degrees Fahrenheit), the combustion air blower(s) shut off. At this point, the fire "banks". When the air combustion blower(s) turn back on, there may not be enough coals to restart the fire. You will then need to restart the fire. If this situation occurs, you may want to transfer to your standard system for better efficiency.

A new unit will require the establishment of "bed of coals" which will aid in re-establishing proper combustion. This may take a few burn cycles.

## Types of Coal

There are three main types of coal approved for use in a HEATMOR™ furnace. They are Pennsylvania anthracite, Eastern Canadian bituminous and Western Canadian sub-bituminous.

Coal can vary in size by grade. Use “stove” coal or a similar size. Smaller sizes may restrict airflow and larger sizes may not burn efficiently, if at all.

**Please follow all local laws concerning the storage and burning of coal. Contact your local dealer for further information on the types of coal available in your local area.**

## Handling and Storage of Coal

Some types will absorb moisture and expand; therefore it is recommended that coal must be kept dry.

## Loading Coal into the HEATMOR™

Coal may be easily fed into the HEATMOR™ Furnace with a small metal scoop shovel. With some experimentation you will determine the proper filling technique, amounts and frequency of loading for your HEATMOR™ furnace while burning coal. Load coal to the bottom of the firebox door frame fill line. Remove air block off if more overgrate air is needed. Pull out to let more overgrate air through and push back to get more undergrate.



Air tube holds the air restricter.



Air Block Off

## **HEAT TRANSFER FLUID (HTF)**

### Qualities of Water to Use

Heatmor highly recommends the use of Pure Water, such as: Reverse Osmosis, Deionized, or Distilled.

APPROVED WATER MUST MEET THE REQUIREMENTS OF:

PH LEVEL OF 7.0 TO 11.5

CHLORIDE LEVEL OF UNDER 50

HARDNESS UNDER 200 PPM

SOFTENED AND FILTERED TO LIMIT THE AMOUNT OF SOLIDS.

### Heat Transfer Fluid (HTF) Level Maintenance

You can verify the HTF level of your HEATMOR™ by checking the fullness of the bladder. The HTF level gauge (“add HTF” weight) inside the front door of the HEATMOR™ should be up near the bladder, not down near the shelf. An even better method of gauging the fullness of the bladder is to reach up through the bladder cover plate and feel the bladder. The bladder should still have wrinkles in it when the HTF temperature is 180 degrees Fahrenheit. If the filling procedures were done correctly, the bladder would have been the last thing topped up after the water jacket of your HEATMOR™. Refer to [“Filling the HEATMOR™ Outdoor Furnace Initially with Water”](#) for further details or contact your local dealer.

### Removal/Replacement of System HTE

A sediment faucet was factory installed at the back of furnace, it may be used for filling or draining purposes. If for any reason you need to remove the HTF, it must be disposed of in accordance with your Local/State Guidelines.

The use of an In-Line Filling system is not recommended by HEATMOR as it may void your warranty due to the dilution of the HTF

When refilling your HEATMOR™, refer to [“Filling the HEATMOR™ Outdoor Furnace Initially with Water”](#)



## Freeze Protection

The unit comes prefilled with concentrated DOWFROST™ HD corrosion inhibited propylene glycol. DOWFROST™ HD has Burst Protection to -60 degrees Fahrenheit. DOWFROST™ HD MUST BE DILUTED WITH APPROVED WATER. Heatmor highly recommends the use of Pure Water, such as: Reverse Osmosis, Deionized, or Distilled.

Maintain the minimum of a 40% DOWFROST™ HD to approved water ratio at all times.

Before draining the HTF, please refer to "[Removal/Replacement of System HTF](#)".

**Only use additives as instructed by your HEATMOR rep., as they may void your warranty**

## Adding Freeze Protection Products

Maintain the minimum of a 40% DOWFROST™ HD to approved water ratio at all times.

## **BLADDER ASSEMBLY**

### *Principles*

It is best not to have the system HTF, that is in the water jacket, exposed to the atmosphere. This is because of system HTF loss through evaporation. When system HTF is lost, it must be replenished or soon the water jacket would be empty. Not only is replenishing lost system HTF a nuisance, it is also accelerating the corrosion process throughout the total system, because adding fresh system HTF is also adding more corrosion causing minerals.

### Bladder

#### *Principle of the Bladder*

The HEATMOR™ is designed to be a semi-closed system.

The bladder is a reservoir that accepts the increased volume of HTF that results when the HTF within the water jacket expands as it is heated. Similarly, when the HTF within the water jacket cools down, HTF is drawn out of the bladder.

#### *Operation of the Bladder*

The bladder has a capacity of approximately 8 gallons. Normally, the bladder should have a small amount of HTF in it at all times. As the furnace cycles, the amount of HTF in the bladder will increase and decrease. If at any time the furnace is requiring additional HTF it will use the reserve HTF in the bladder before having to be topped up.

#### *Filling the Bladder with HTF*

- 1) Keep your bladder valve closed when filling your stove with HTF, but open at all other times. Your bladder should have a small amount of HTF in it.

#### *Maintenance / Result*

To maintain your furnace bladder simply keep the bladder so that it has a small amount of HTF in it, so the bladder continues to supply the water jacket with HTF. If the HTF level does run low, the possibilities of HTF boiling and firebox warping are increased.



Bladder

## Removal and Replacement of the Bladder

- 1) Turn off the bladder ball valve located at the front of the HEATMOR™ furnace.
- 2) Remove the bladder cover plate held in place by two wing nuts.
- 3) Remove the HTF level gauge and pull the rope through the eyelet.
- 4) Remove the hose clamp from the bladder ball valve.
- 5) Pull the bladder hose away from the bladder ball valve and let the HTF drain from the bladder. **Be careful, it could be warm.**
- 6) Remove the old bladder and install the new bladder.
- 7) Install the new bladder with the valve stem in the front of the bladder compartment with the hose coming down through the center of the tube. Connect the tube to the bladder valve's 1/2 inch barbed fitting and tighten hose clamp.
- 8) Thread the rope over the bladder and through the eyelet. Attach the "add HTF" plate onto the rope.
- 9) Open the bladder ball valve and refer to "[Filling the HEATMOR™ Outdoor Furnace Initially with Water](#)"



Bladder Ball Valve

## Bladder Ball Valve and Bladder Hose

### Principle of the Bladder Ball Valve and Bladder Hose

The bladder ball valve provides HTF flow control in maintaining the bladder and filling the furnace with HTF. The bladder hose provides a means for the HTF to freely flow from the water jacket to the bladder allowing expansion and contraction.

**WHEN THE HEATMOR™ FURNACE IS OPERATING, THE BLADDER BALL VALVE MUST BE OPEN.**

### Maintenance / Result

To maintain the bladder ball valve, open and close the valve periodically to prevent it from seizing. Ensure that the hose clamp is tightly fastened, securing the bladder hose to the bladder and to the bladder ball valve.

**CAUTION** ABSOLUTELY NO FIRE IN THE FIREBOX WHEN PERFORMING THIS PROCESS. DO NOT PERFORM THIS PROCESS WHEN UNIT HTF TEMPERATURE IS UNSAFE. ALWAYS WEAR PROPER PERSONAL PROTECTIVE EQUIPMENT WHEN WORKING WITH HTF AND CHEMICALS.

## Removal and Replacement Of Bladder Ball Valve

- 1) Turn off the power to the furnace.
- 2) Drain the HTF to below the bladder valve spud to prevent HTF from draining while you are replacing the valve.
- 3) Loosen the hose clamp holding the bladder hose to the bladder ball valve.
- 4) Remove the bladder hose from the bladder ball valve and let the HTF drain from the bladder.
- 5) Remove the old bladder ball valve and install the new bladder ball valve.
- 6) Attach the bladder hose to the bladder ball valve and tighten the hose clamp.
- 7) Keeping the bladder ball valve closed, add HTF until furnace is full.
- 8) Open the bladder ball valve and refer to "[Filling the HEATMOR™ Outdoor Furnace Initially with Water](#)"
- 9) Turn on the power to the furnace

## Heat Transfer Fluid Level (HTF) Level Gauge

### Principle of the HTF Level Gauge

The HTF level gauge simply gives you an accurate reading of when the bladder is full or empty of HTF.

### Maintenance / Result

To maintain your HTF level gauge, ensure that it can move freely through the eyelet. If it does not move freely, the risk of the rope wearing and breaking or inaccurate readings are possible.

### Removal and Replacement

- 1) Drain some of the HTF from the furnace to allow you to maneuver around the bladder.
- 2) Remove the HTF level gauge from the rope.
- 3) Remove the rope and replace it with a new HTF level gauge rope.
- 4) Thread the rope over the bladder and through the eyelet
- 5) Attach the HTF level gauge.
- 6) Refill the bladder refer to "[Filling the HEATMOR™ Outdoor Furnace Initially with Water](#)"



Add Fluid Sign

## Bladder Cover Plate

### Principle of the Bladder Cover Plate

The bladder cover plate simply gives protection to the bladder from possible back flashes and excess heat. It helps hold up the bladder in position, and when it is removed allows a large space to service the bladder.

### Removal and Replacement

To remove and replace the bladder cover plate, loosen the wing nuts and install the new cover plate. Tighten the wing nuts.



Bladder Cover Plate

## Fluid Level Sensor

### Principle of the Fluid Level Sensor

When the Fluid is lower than the sensor the light on the bottom left of the Electronic Aquastat Control will illuminate. The Aquastat will not allow the fans to engage until the HTF level is restored. This protects the furnace from an overheat condition.

**Note:** If the light states illuminated, call your local Dealer.

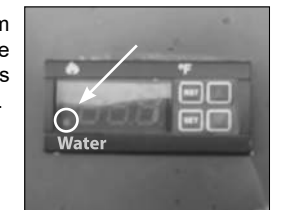

Electronic Aquastat Controller

### WATER JACKET

#### *Principles of the Water Jacket*

HTF within the water jacket absorbs heat produced in the firebox. The heated HTF is used to transfer heat from the HEATMOR™ into the building needing heat. The water jacket and the firebox are one welded component and can be replaced.

#### *Maintenance*

Keep the proper mixture of HTF.

#### Supply Line and Return Line Threaded Connectors

#### *Principles*

The HEATMOR™ furnace is designed to draw the supply (hot) HTF from the bottom of the water jacket. This may seem irregular (people know hot water rises), but this method mixes the HTF in the water jacket better and often extends pump life. The return (cooler) HTF connects to the, upper, rear spud of the HEATMOR™. A circulator (pump) moves the HTF at approximately three to 10 gallons per minute, through both lines under very little pressure (3 psi). **Always attach a BRASS fitting into the STAINLESS STEEL spud to prevent galvanic corrosion.**

#### Relief Vent Pipe with Elbow

#### *Principles*

The relief vent pipe is connected to the top of the water jacket. When the HTF within the water jacket is heated it expands, the HTF will expand into the bladder, instead of out onto the roof.



Relief Vent Pipe with Elbow



### FIREBOX AND OTHER COMPONENTS

#### Firebox

#### *Principles of the Firebox*

Coal is burned inside the firebox to generate heat. This heat is absorbed into the HTF in the water jacket. The firebox and water jacket are one welded component and can be replaced. When the HTF is up to temperature and the combustion air blowers are off, the firebox must be airtight.

#### *Operation of the Firebox*

Temperatures within the firebox can reach 2000 degrees Fahrenheit. Smoke exits from the firebox into the flue. During normal operation, there will be a slight buildup

of black creosote on the firebox walls. This buildup will sometimes appear flaky.

#### *Maintenance / Result*

Coal should not be thrown into the firebox in a rough manner. Creosote should never have to be scraped off the firebox walls.

#### *Removal and Replacement of the Weldment*

- 1) Contact your dealer
- 2) Refer to Online Video "[2016 HEATMOR™ High Efficiency Weldment Changeout](#)"

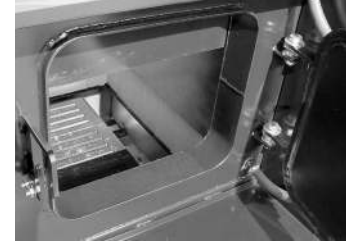

Firebox

## Firebox Door

### Principles of the Firebox Door

The firebox door is HTF cooled to prevent warping of the door. It also acts like a water jacket, absorbing heat from the fire, and placing that energy into the HTF. Being HTF cooled, the front of the firebox door will never be hotter than the HTF. The cold outside atmospheric air is drawn over the warm surface of the firebox door, by the combustion blowers, which is then warmed and forced into the firebox as warmed combustion air. This lessens the time needed for the interior of the firebox to reach that high smoke burning temperature. It is important that the firebox door seal maintains an airtight seal.

### Operation of the Firebox Door

HTF from the main water jacket flows in a loop between the firebox door and the water jacket by natural thermal siphoning. Since there is no pump involved, there is very little pressure. During this process, the HTF cools the door and the HTF in the door is heated.

### Maintenance / Result

**A properly adjusted firebox door will not allow smoke to enter or escape the firebox.**

Maintain a tight seal all around the perimeter of the firebox door at all times. There may be times when the perimeter of the firebox door will build up with “creosote strings,” especially along the bottom.

To keep the perimeter clean, occasionally scrape down to the steel. **Do not cut**, scrape or disturb the actual soft, pliable seal. Keep the door correctly adjusted on the hinges so that the pliable seal is being forced against the firebox ledge. Keep all nuts and bolts on the handle, latch and hinges properly adjusted.

The seal itself consists of a rope in the groove of the firebox door, covered with high temperature silicone.

Failure to manage and maintain the firebox door could result in premature replacement of parts and a buildup of creosote.



Firebox Door Handle



Firebox Door Handle



**ABSOLUTELY NO FIRE IN THE FIREBOX WHEN PERFORMING THIS PROCESS. DO NOT PERFORM THIS PROCESS WHEN UNIT HTF TEMPERATURE IS UNSAFE. ALWAYS WEAR PROPER PERSONAL PROTECTIVE EQUIPMENT WHEN WORKING WITH HTF AND CHEMICALS.**

### Removal of Firebox Door

- 1) Turn off power to the combustion air blowers.
- 2) Ensure that the fire in the firebox is extinguished.
- 3) Stop the flow of HTF from the water jacket through the door hoses by pinching the two door hoses shut. Make a collar of cardboard between the jaws of two pairs of vice-grips and clamp the door hoses tight at the center point of their length.
- 4) Loosen the hose clamps and remove the door hoses from the firebox door.
- 5) Loosen and remove the nuts and bolts holding the firebox door on to the hinge.
- 6) Remove the firebox door from the hinges and remove the handle from the firebox door.

### To replace the firebox door, follow these steps:

- 1) Replace the bolts and nuts onto the new door just as they were removed.
- 2) Hang the firebox door on the hinges loosely, with the nuts just slightly more than finger tight, and attach the handle on to the firebox door allowing the handle to just barely float freely.

**NOTE:** Ensure there is a tight seal around the firebox door frame while it is closed and latched shut. The firebox door must remain parallel with the door frame.

- 3) Close the firebox door and allow the handle to rest freely in the latch.
- 4) Get the firebox door parallel with the door frame ledge and tighten the nuts and bolts a little more firmly onto the hinges. You may want to block up the firebox door until the hinge is re-tightened.
- 5) Re-attach the door hoses, tighten the hose clamps, and unclamp the vice-grips.
- 6) Light a fire in the firebox; then ensure that there are no air leaks. You will be able to detect them by noticing smoke escaping through any air leaks, while the blowers are running.

**NOTE:** If there is smoke leakage around the firebox door or one corner of the door, it is adjustable.

- 7) Lift the door handle off the latch and allow it to rest loosely.
- 8) With two 1 1/8 inch wrenches, loosen the appropriate hinge (top or bottom) so it is slightly more than finger tight. (Use only the bottom nut to adjust.)
- 9) While the bolt is slightly tight, rap the nut between the hinge halves, with a punch and hammer.
- 10) With hinge bolt reset, tighten the lower nut.
- 11) The top and bottom firebox door should remain parallel with the door frame. If it tends to sag, block it up with appropriate blocking until the hinge is re-tightened.
- 12) When replacing the Firebox Door, it is recommended to replace the Door Hoses at this time.

## Firebox Door Hoses and Elbows

### Principle of the Door Hoses

The door hoses allow HTF to circulate between the firebox door and the water jacket.

### Operation of the Door Hoses

The door hoses allow HTF from the water jacket to pass through the firebox door, through thermal siphoning. Refer to “[Firebox Door](#)”

### Maintenance / Result

Maintaining the door hoses and elbows ensures that HTF is able to flow through the door. Build-up (calcium) in the elbows is possible over time, which slowly reduces the HTF flow through the door. If HTF does not flow freely through the hoses to the firebox door, you may hear popping sounds in the door. Once the hoses are around five years old or if they show signs of wear, they should be replaced. Replacement of hoses or cleaning of the elbows is always easier if the HTF is cool rather than hot. To clean the elbows, remove the hoses and use a pipe cleaning brush to clear out the build-up.



Door Hose

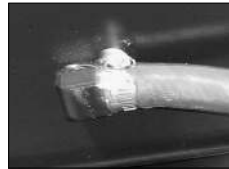

Elbow



**ABSOLUTELY NO FIRE IN THE FIREBOX WHEN PERFORMING THIS PROCESS. DO NOT PERFORM THIS PROCESS WHEN UNIT HTF TEMPERATURE IS UNSAFE. ALWAYS WEAR PROPER PERSONAL PROTECTIVE EQUIPMENT WHEN WORKING WITH HTF AND CHEMICALS.**

### Removal and Replacement Door Hoses

**NOTE:** Top Door Hose is 20in, bottom Door Hose is 18in

- 1) Turn off power to the air combustion blowers.
- 2) Ensure that the fire in the firebox is extinguished, which will allow the HTF to cool.
- 3) With hose clamps or vice-grips, pinch the door hoses in the middle of the hose.
- 4) Before removing the old door hose, cut the new pieces of door hose, one at 18 inches and the other at 20 inches.



Clamping hose

### These measurements are critical.

- 5) Pinch the new door hose in the middle of the hose, creating a tight seal.
- 6) Loosen the hose clamps on each end of the door hose.
- 7) Remove the first end of the door hose needing replacement.
- 8) Push on the end of the new door hose and repeat the steps for the opposite end of the hose.
- 9) Tighten the hose clamps, securely fastening the door hose to the nipple on the furnace or firebox door.
- 10) Remove the vice-grips pinching the door hoses. This will allow HTF to flow through.
- 11) Check for leaks.
- 12) Repeat the steps to change additional door hoses.

## Firebox Door Handle

### Principles of the Firebox Door Handle

Fastened to the firebox door, the handle provides a secure method of controlling the opening and closing of the firebox door. By opening the firebox door, (only until the door handle hits the second stage of the safety latch), gives a space for fresh air to enter the firebox without the risk of a “flash back.” The firebox door handle is also designed to “stick” to the **firebox door handle holder** on the outer door. This procedure prevents either of the doors closing while the Heatmor™ is being loaded with coal.



**ABSOLUTELY NO FIRE IN THE FIREBOX WHEN PERFORMING THIS PROCESS. DO NOT PERFORM THIS PROCESS WHEN UNIT HTF TEMPERATURE IS UNSAFE. ALWAYS WEAR PROPER PERSONAL PROTECTIVE EQUIPMENT WHEN WORKING WITH HTF AND CHEMICALS.**

### Maintenance / Result

To maintain the door handle, ensure the handle closes and opens fairly easily. If the handle closes too hard, it will be hard to open and close the door. If the closure is too loose, it will be harder to obtain a perfect seal around the door. If you do not have a firm seal, you could potentially create an air leak resulting in further complications. Refer to “[Checking for Air Leaks](#)” for further details or contact your local dealer. You can adjust the two bolts on the latch for correct closure.

### Removal and Replacement Door Handle

- 1) Turn off power to the blowers.
- 2) Ensure the fire in the firebox is extinguished.
- 3) Loosen and remove the nut on the bearing and the nut on the mounting plate.
- 4) Replace the handle
- 5) Replace and tighten the nut on the bearing and the nut on the mounting plate.

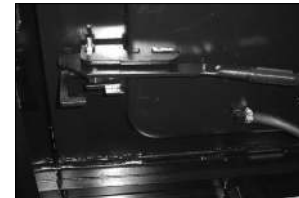

Firebox Door Handle



## Firebox Door Hinge

### *Principle of the Firebox Door Hinge*

Supports the firebox doors and allows for adjustment.

### *Maintenance / Result*

The adjustable hinge works in conjunction with the door handle and the firebox door. The hinge has slotted holes so the firebox door can be adjusted to provide a solid fit against the firebox frame. Secure and stable, the hinge allows the firebox door to swing free and smooth.

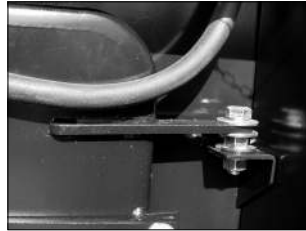

Firebox Door Hinge

## Firebox Door Latch

### *Principles of the Firebox Door Latch*

The safety latch is designed to provide additional safety by preventing the firebox door from opening too quickly, potentially allowing a “flashback.” The latch is adjustable and replaceable.

### *Maintenance/result*

The latch is adjustable with the two bolts. The two bolts must be tightened firmly. When properly adjusted, the firebox door handle will close and open with ease and create a perfect seal around the door.



Firebox Door Magnet

## Firebox Door Magnet

### *Principles of the Firebox Door Magnet*

The firebox door magnet provides a means of holding **both** the outer front door and the firebox door completely open while the operator is loading coal into the HEATMOR™.

### *Operation*

- 1) Open the firebox door as you step backwards towards the exterior door. This allows you to be out of the way if there is a “flash back” or smoke exiting the door opening.
- 2) Stick the firebox door handle onto the firebox door handle magnet provided on the outer door.
- 3) To remove the firebox door from the magnet, turn the handle to the left and pull the inner door away by the handle.

## Firebox Door Gasket

### *Principles of the Firebox Door Gasket*

The firebox door gasket creates an airtight seal between the firebox door frame and the firebox door. It is a pliable seal that can be removed and replaced if damaged or worn.

### *Maintenance/Result*

Occasionally, scrape the perimeter of the firebox door to keep it clean. **Do not cut**, scrape or disturb the pliable seal.



Firebox Door Gasket

Keep the door correctly adjusted on the hinges to ensure the pliable seal is being forced against the firebox door frame. Keep all nuts and bolts on the handle, and latch and hinges properly adjusted.

The seal itself consists of a fiberglass rope in the groove of the firebox door, covered with high temperature silicone.

Failure to manage and maintain the firebox door gasket could result in air entering into the firebox when the combustion air fans are off or smoke escaping around the seal when the combustion air blowers are running.

Air entering the firebox when the **fans are off** results in the coal continuing to smolder, resulting in the furnace overheating and more than a “wiff” of smoke emitting from the chimney. Often, this type of smoke has an unpleasant odor. Creosote will also be formed.

When the fans are running and the door seal is not sealing tightly, smoke will be forced through the leaking door seal. This causes the front of the furnace to be smoke filled and soon the front of the firebox will be covered with soot. Premature replacement of parts and a buildup of creosote will result.



**ABSOLUTELY NO FIRE IN THE FIREBOX WHEN PERFORMING THIS REPAIR. DO NOT PERFORM THIS REPAIR WHEN UNIT HTF TEMPERATURE IS UNSAFE. ALWAYS WEAR PROPER PERSONAL PROTECTIVE EQUIPMENT.**

## *Removal and Replacement*

- 1) Using a sharp knife, carefully cut away the silicone seal around the firebox door seal channel.
- 2) Remove the old gasket from underneath the old silicone.
- 3) Remove all old silicone with a wire wheel or steel brush.
- 4) Replace with a single length of new gasket material. Do not pack or over stretch the new gasket. Once in place allow, the material to “relax” before cutting to length.
- 5) Cover the door rope with silicone and tool to a smooth, flat, finish.
- 6) Leave the firebox door open for 24 hours to allow silicone to dry completely.

**NOTE:** You will need 66 inches of 1 inch door rope material plus two tubes of caulking. The door rope kit is available from your HEATMOR™ dealer.

## Firebox Door Frame

### *Principles of the Firebox Door Frame*

To provide a small edge that will seal into the firebox door gasket to provide an airtight seal.

### *Maintenance / result*

Keep the door frame cleaned down to the steel at all times. Failure to do so results in a build up of creosote, resulting in a barrier to an airtight seal, air leaks and premature gasket replacement.



Firebox Door Frame

## Firebox / Base Connector Clamps

### Principles of the Firebox / Base Connector Clamps

To allow easy separation of the firebox / water jacket assembly and the base, if repairs are needed to either assembly

## Firebrick

### Principles of the Firebrick

Once heated, the firebricks hold heat for a long period of time. This creates a warm firebox between cycles. Because of this heat, when the combustion air blowers start, the fire inside the firebox can re-ignite and reach the smoke burning temperature of 1100 degrees Fahrenheit much faster.



Firebrick

### Removal and Replacement

- 1) Let the fire go out and allow the ashes to cool completely. Remove the ashes from the firebox.
- 2) Crawl into the firebox.
- 3) Remove the black, high temperature silicone bead at the bottom of the firebrick.
- 4) Using a pry-bar, remove the broken brick.
- 5) Replace the broken brick.
- 6) Apply a new bead of high temperature silicone along the base of the brick.

## Standard Grates

### Principles of the Standard Grates

Grates allow combustion air from the combustion air blowers to pass from below the grates, up through the grates, through a shallow depth of coals and then to the bottom of the burning fire. This way the coal will burn completely into a fine powder that will flow through the grates into the ash pan. The embers will be more apt to ignite and set the wood ablaze when there is airflow around them.



Standard Grates

### Maintenance/Result

- 1) Never make the slots in the grates wider than factory dimensions. If hot coals can pass through the grates, warping of the grates may result.
- 2) Make sure the grates are always resting in the grooves of the ash pit. If the grates move out of place, it may result in hot coals slipping under the grates causing warp age of the grates.
- 3) Make sure the narrow side of the slot is next to the fire.
- 4) Replace broken grates immediately or a chain reaction of broken grates may result.

## Removal and Replacement

- 1) Allow the ashes to burn completely and extinguish.
- 2) Push the ashes to the back of the firebox or remove all the ashes from the firebox.
- 3) Run a small pry-bar around the perimeter of the grate and the edge of the ash pit to loosen the grate.
- 4) Lift out the broken grate.
- 5) Clean the edge of the ash pit in which the new grate will sit.
- 6) Install the new grate. Make sure to install the new grate with the narrow width of the slot towards the fire.

## Optional Shaker Grates

### Using Your Shaker Grate System

**There are two main modes of operation for the Shaker Grate System. These are Shake mode and Dump mode.**

Shake mode is used mainly for daily use and consists of handle movement with the stop **in place**. Moving the handle back and forth with the stop in place allows for the breaking up and release of small pieces of klinker and ash into the ashpan. This should be done daily or whenever coal is added to the furnace. See figure 1.

The second mode is Dump mode and consists of handle movement with the stop moved **out of the way**. Moving the handle back and forth, with the stop out of the way, allows for full movement of the shaker grates as well as the breaking up and release of large pieces of klinker into the ashpan. Dump mode is needed when the klinker buildup on the shaker grates is such that it causes restriction of airflow to the fire. See Figure 2.

During normal operation the shaker grates must be in a neutral position as shown in Figure 3.

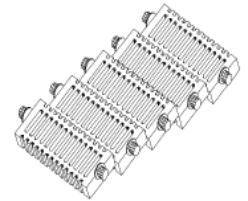

Figure 1

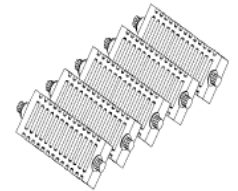

Figure 2

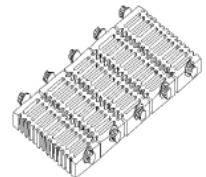

Figure 3

**It is important that after using the shaker system in dump mode, all klinker and ash is cleared out from the ashpan leaving NOTHING behind. Anything left under the shaker grates can re-ignite causing damage to the shaker grates.**

## Sand

### *Principles of Sand in the Base of the Firebox*

The HEATMOR™ furnace, in boiler terms, is a “dry base boiler.” This is to say there is no HTF around the base of the firebox. The firebrick and sand hold and release heat to the firebox during the off cycle. This shortens the time when smoke will be emitted.

A sand base provides complete corrosion protection to the most corrosion prone area of a furnace.

### *Maintenance/Result*

The sand should never need to be removed. When stirring the ashes, rake only the area over the grates. There is no need to stir the areas where the sand is located. Maintain the sand level to the top of the grates. Check the level on a yearly basis and add sand if necessary. Refer to page 19 for types of sand to use.

### *Removal and Replacement*

- 1) Allow the ashes to extinguish and then remove all the ashes from the firebox.
- 2) Allow the HTF to cool down.
- 3) One person should get into the firebox and with a small scoop, remove the sand from around the ash pit.
- 4) Replace as above.



Sand

## Flash Curtain / Heat Shield



**ABSOLUTELY NO FIRE IN THE FIREBOX WHEN PERFORMING THIS REPAIR. ALWAYS WEAR PROPER PERSONAL PROTECTIVE EQUIPMENT.**

### *Principles of the Flash Curtain / Heat Shield*

The purpose of the flash curtain is to decrease the amount of smoke emitted from the door when loading coal into the firebox. The flash curtain decreases the size of the firebox opening, making that size more in proportion to the area the natural draft of the chimney will draw from. As a heat shield, the flash curtain restricts the amount of direct heat that contacts the firebox door directly.



Flash Curtain

### *Maintenance/Result*

Leaving the flash curtain in place is effective for the principles outlined above.

### *Removal and Replacement*

- 1) The plate is slotted at the top and fits loosely onto two hooks, installed above the firebox door opening.
- 2) With the ashes cooled down, lift up on the plate until it releases itself from the hooks.



Proper placement of Flash Curtain



### AIR SUPPLY

Combustion Air Blower(s) and Flipper Assembly(s)

**THE FLIPPER MUST OPERATE PERFECTLY OR PROBLEMS QUICKLY ARISE.**

#### Principles

The combustion air blowers and flipper assemblies supply air for combustion inside the firebox. The flipper assemblies keep air out of the firebox when combustion is not needed. These components are removable and serviceable.

#### Operation of the Combustion Air Blower(s) and Flipper Assembly(s)

- 1) When the HTF temperature reaches the **high HTF temperature** setting, the aquastat turns the blower(s) **off**. At this point, the hinged flipper falls shut, preventing air from getting into the firebox.
- 2) When the HTF temperature reaches the **low HTF temperature** setting, the aquastat turns the blower(s) **on**. At this point, the hinged flipper opens from the force of the blower(s) and allows air into the firebox.
- 3) The hinged flipper **must** completely open and close all of the time. When it is closed, it must seal completely. If more than a “wiff” of smoke is coming from the chimney when the blower(s) has been off for approximately 10 minutes, this is a strong indication the hinged flipper is not shutting properly.

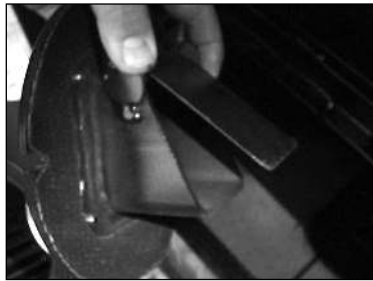

Flipper Assembly

#### Maintenance / Result

- 1) Clean the fin blades of the squirrel cage fan.
- 2) Ensure the flipper assembly is clean and seals completely when closed.

#### Steps to Maintain your Blower / Flipper Assembly.

- 1) Turn off the main power supply to the furnace.
- 2) Loosen and remove the two thumb nuts securing the blower / flipper assembly to the large air tube, and remove the blower / flipper assembly.
- 3) With a small brush, scrape any dust or residue that has accumulated on the fins of the blower.
- 4) With a small brush or scraper, scrape any dust or residue built up on the flipper assembly.
- 5) Ensure the flipper is resting completely on its seat. If it is not resting completely, perhaps there is dust or soot built up on the flipper, or some other obstruction not allowing it to close tightly.
- 6) Securely fasten the blower/flipper assembly back to the large air tube ensuring there are no air leaks.

### Removal and Replacement

- 1) Turn off the main power supply to the furnace.
- 2) Loosen and remove the thumbnuts securing the blower/flipper assembly to the air tube.
- 3) Disconnect the electrical wire from the blower.
- 4) Remove the flipper assembly from the blower by removing the four bolts. This will require a 7/16 inch wrench.
- 5) Attach the existing flipper assembly to the new blower.
- 6) Rewire the electrical wire to the blower. **Contact a licensed electrician if you have any questions.**
- 7) Securely fasten the blower back to the air tube ensuring that there are no air leaks.



**THE FLIPPER MUST OPERATE PERFECTLY OR PROBLEMS QUICKLY ARISE.**

If the flipper is unable to open and close freely, or remains partially open or partially closed, the furnace will starve for air resulting in a smoldering fire instead of an intense fire. More smoke and creosote is the result. If the flipper is not operating correctly, it causes a snowball effect of problems. **MAINTAIN THE FLIPPER!**

### Air Box(s)

#### Principle

The air box is designed to distribute the appropriate percentage of air from the blower(s), into different areas of the firebox so the fire will burn efficiently and clean.

#### Maintenance / Result

Check for ashes in the air box. If ashes are in the air box, they may interfere with the opening and closing of the flipper. If ashes cover the air outlets, less air will get into the firebox. When raking ashes, be careful not to pull the ashes over or into the air box(s). **Be certain the ashes are cold and extinguished before attempting to remove ashes from the air box.**

To maintain the air box, remove the blower / flipper assembly and clean the ashes out of the air box with a mini-vacuum that is made for ashes, metal brush or metal scraper. You may need to loosen up hard packed ashes. Securely fasten the blower / flipper assembly back onto the large air tube ensuring there are no air leaks.



Air Box

## Combustion Air Tube

### *Principle*

The combustion air tube allows air flow from the airbox to the ashpan. It helps to provide combustion air into the ashpan, through the grates and to the bottom of the charge of coal.

### *Maintenance*

Maintenance should be completed regularly to ensure no ash has accumulated inside the combustion air tube, limiting airflow. If the furnace does not have proper airflow, the combustion efficiency is reduced, resulting in increased smoke and creosote.

## Automatic Fan Switch (A.F.S.)

The Automatic Fan Switch must operate correctly for safe operation of the Heatmor.

### *Principle*

The fan switch turns the fan on while the outer door is opened to clear the possible excess fuel build up in the firebox. Along with normal recommended, safe firebox door opening practices, the risk of a flash back is greatly reduced.

### *Operation*

The Automatic Fan Switch automatically turns on the fan when the front outer door is open. The Automatic Fan Switch can be over ridden by the Front light and Combustion Air Blower Control Switch and the high limit will also override the Automatic Fan Switch.

### *Maintenance/Result*

Ensure that the outer door closes properly to activate the Automatic Fan Switch. If the outer door does not close properly the switch could stay in the "fan on" position or if the Automatic Fan Switch fails in the "fan on" position, the Heatmor combustion fan will continue to run until the high limit is tripped. Ensure that the Automatic Fan Switch is working properly: if the Heatmor is off when you approach the Heatmor, the fan should come on when you open the outer door, if it does not, then your Automatic Fan Switch has failed in the "fan off" position.



Combustion Air Tube



Automatic Fan Switch

## **CHIMNEY AND TOP FLUE**

### Chimney

#### *Principles*

The principle of the chimney is to discharge smoke from the flue into the atmosphere.

#### *Maintenance*

**Make sure chimney and chimney extensions are clean and in good condition.**

The chimney may be cleaned from the top with a chimney-cleaning device. Inspect the chimney once a month during the heating season to ensure there is not an excessive amount of creosote. If an excessive creosote buildup has occurred, it must be removed promptly to reduce the risk of a chimney fire.

When the unit is shut down for the summer, inspect and clean the chimney for the next heating season. When the furnace is not in use, cover chimney so nothing can enter.

### Chimney Extension(s)

#### *Principle*

Chimney extensions discharge smoke higher into the atmosphere. They also discharge sparks higher into the atmosphere, so they have more chance of being burned out before they reach the ground. Approved chimney extensions may be added to the chimney to discharge smoke to higher levels. Discharging smoke at a higher level helps keep smoke above property level, especially on low pressure or cloudy, hazy or wet days. When installing chimney extension you must have no less than three tech-12 screws (self-tapping). Any chimney extension exceeding 6ft must be supported with guide wires.

#### *Maintenance / Result*

- 1) See chimney maintenance above.
- 2) Purchase approved chimney extensions that fit together correctly. If the extensions don't fit properly, creosote will run down the outside of the chimney extensions and cause corrosion to the roof.
- 3) Annually remove chimney extensions for cleaning and safety purposes.

**In case of chimney fire shut off combustion fan switch and consult your dealer.**

8 inch by 32.5 inch steel chimney connector extensions are available from your local dealer.

### Rain Caps and Spark Arrestor:

Consult your local dealer for optional components.



Chimney

## Creosote

Creosote - Formation and Need for Removal -

When coal is burned slowly, it produces tar and other organic vapors, which combine with expelled moisture to form creosote. The creosote vapors condense in the relatively cool chimney flue of a slow burning fire. As a result, creosote residue accumulates on the flue lining. When ignited this creosote makes an extremely hot fire.

The chimney connector and chimney should be inspected at least twice monthly during the heating season to determine if a creosote buildup has occurred.

If creosote has accumulate it should be removed to reduce the risk of a chimney fire. DO NOT connect to a chimney flue serving another appliance.

## Flue

### *Principles of the Flue*

The flue allows the passage of heat, smoke, and gases from the firebox to the chimney. Because the flue is surrounded with Heat Transfer Fluid (HTF), heat is transferred to the HTF surrounding the flue. This captures heat that would otherwise be lost out the chimney, assisting in the process of a more efficient burn.

### *Maintenance*

Only dust should accumulate in the flue. If creosote develops, the cause should be determined and eliminated.

- 1) Inspect and clean the flue once a month during the heating season.
- 2) Remove the one-half inch nuts holding the flue cover and remove the cover.
- 3) Using the flue scraper provided with the HEATMOR™ furnace, push the dust to the front of the flue and let it fall down into the firebox. Remove this dust as you would ashes. If a lot of dust is dropped down, be certain that the air slot of the front air box is not covered.
- 4) Re-attach the flue cover plate, making sure to tighten the nuts to make an airtight seal.
- 5) If the HEATMOR™ Furnace unit is shut down for the summer, inspect and clean the flue for the next heating season.



Flue



Removing Flue Cover



Flue Scraper

## Flue Cover

### *Principles*

The flue cover is airtight and provides access to the flue for cleanout.

## Flue Scraper

### *Principles*

The flue scraper is provided for cleaning the flue only and is not designed to be used for other purposes.

## ASHES

### Ash Management and Ash Removal

- 1) **If ash management is deficient, the HEATMOR™ will not perform to its optimum.** It is time well spent to ensure proper ash management. In the long run, the operator will be paid back many times over in higher efficiency and better performance. Improper ash management results in one unfavorable condition starting a chain reaction of additional problems.
- 2) Allow **all** coal in the firebox to fully burn out every day or two, and use this opportunity to rake the ashes in the firebox, down into the grates. By timing the loading of coal so the HTF temperature drops approximately 10 degrees below the low HTF temperature set-point, means all fuel in the firebox is used up, and the only thing burning are the ashes. An hour or two of this condition will ensure an easy, smoke free opportunity to rake the ashes.

When all fuel has been burned out of the ashes, they will be a pale brown color. With a light raking assistance, they will fall through the grates into the ash pan below. It is best to rake the area over the grate, every day, such that the grates are at least 25 percent clear of ash. This allows upward movement of combustion air.

**NOTE:** You Can Obtain Ash Rakes From Your Local Dealer

- 3) If the ashes don't flow into the ash pan while being raked, the ash pan is possibly full. Removing the ashes from the ash pan before it is completely full ensures the proper airflow from below the grates is maintained and also ensures the ashes can drop through the grates into the ash pan.

**NOTE:** Ashes should be removed before the ash pan is completely full.

- 4) Be careful not to pull the ashes too close to the front (or the rear) of the firebox, blocking off the combustion airflow from the air boxes.
- 5) Do not allow ashes to build up on top of the grates. Air needs to flow through the grates to fuel the fire. A blocked grate can cause inefficient or non-existent combustion conditions.
- 6) A rule of thumb with coal is to remove ashes daily as coal has a high ash content. Coal requires a large amount of undergrate air so the ash pan needs to be kept clean. If you find that it is not necessary to clean ashes daily adjust schedule as needed.
- 7) Coal has a high amount of minerals as well as ash content and may form "clinkers". It is recommended to agitate the coal/ash on the grates with rake as often as every 12 hours to break these up and cause ashes to fall through the grates. Any large pieces that don't break can be removed with a spade or fire tongs.
- 8) Completely burned ashes will appear like flour. They may be dusty when being removed with the auger. **A particle mask should be worn when removing ashes with the auger.**
- 9) Removed ashes should be stored in a **steel** container, sealed with a **steel** tight fitting lid, and placed in an area free of combustible materials for a few days, to allow the ashes to completely cool before being disposed.

With proper handling, it is not necessary to let the fire go out or the ashes to cool before removing ashes.

## Ash Pan

### Principles

The ash pan is a storage reservoir for completely burned ashes and provides support for the grates. It is also a distribution area for the combustion air that flows upwards through the grates. A reasonable amount of ashes (two to four gallons) should be removed during each ash removal. The ash pan is replaceable.

### Removal and Replacement

- 1) Remove all sand from base area.
- 2) Remove small air pipe leading from ash pan to front air box.
- 3) Slide ash pan approximately three inches towards the front of the HEATMOR™ base, to free the ash pan from the ash auger tube at the back of the ash pan.
- 4) Lift the ash pan straight up and remove through the firebox door opening.
- 5) Replace with a new or repaired unit.
- 6) Replace sand.



Ash Pan (below grates)



Disconnect power before removing ashes.

## Ash Auger

### Principles

The auger provides a convenient and cleaner method of removing ashes from ash pan.

### Operation

- 1) **The ash auger should never be left in the ash pan between clean-outs of ashes.** Doing so will interfere with the required combustion airflow beneath the grates, and required combustion airflow up through the grates.
- 2) Twist the auger into the ashes and either screw or pull the ashes out.
- 3) A proper method of storing the ash auger is to attach a six inch PVC pipe, three feet long, to the side of the HEATMOR™. Storing the auger in the tube will keep it from being frozen into or under snow.



Ash Auger

## Ash Auger Tube

### Principles

The ash auger tube is a six inch diameter tube that extends from the rear of the ash pan, to approximately four inches past the cladding of the HEATMOR™. This extension allows placing a container under the tube to catch the ashes.

### Ash Auger Tube Cover Plate

#### Principles

The auger tube cover plate is a round plate that is secured onto the end of the ash auger tube, creating an airtight seal.

#### Operation

- 1) **When removing ashes, always turn off combustion air blowers.**
- 2) Remove the two thumb nuts.
- 3) Insert the ash auger and remove the ashes.
- 4) Replace the ash auger tube cover plate and securely tighten the two thumb nuts.



Ash Auger Tube Cover Plate



Removal of Ash Auger Tube Cover Plate

### ELECTRONIC AQUASTAT CONTROLLER

#### Principles

The Electronic Controller displays the temperature of the HTF in the water jacket and shuts down the fan(s) when excessive low HTF is detected.

- 1) At its low setting it will turn the combustion air blower(s) on, re-igniting the fire.
- 2) At its high setting it will turn the combustion air blower(s) off, extinguishing the fire.
- 3) The difference between the highest temperature of the HTF and the lowest temperature of the HTF is factory set at 15 degrees Fahrenheit.

#### Operation

The factory settings on this aquastat should not be changed; changing the factory settings will void the warranty and certifications.

#### Maintenance

Keep the face of the dial clean by cleaning periodically with glass cleaner.

#### Removal and Replacement

- 1) Turn off the main power supply to the HEATMOR™.
- 2) Remove the screws from the panel that holds the Electronic Aquastat Controller.
- 3) Pull the controller and panel away from the housing to obtain clearance to work on the Electronic Aquastat Controller on the back.
- 4) Disconnect and label or draw a diagram of each wire connection on the Electronic Aquastat Controller. Refer to the Wiring diagram at the back of this manual.
- 5) Replace the controller and reverse the steps above for re-installation.

**NOTE:** Different makes and models of furnaces may have different controllers. These controllers will NOT be interchangeable. Replace with the correct unit from your dealer.

**NOTE:** The temperature reading on the temperature gauge may not coincide exactly with the temperature of the HTF leaving the back of the HEATMOR™ or the temperature of the HTF arriving into the building being heated. There may also be small variances between the temperature reading on the front of the HEATMOR™ and the high limit aquastats on the back of the HEATMOR™.

#### These variances result from:

- 1) The Electronic Aquastat Controller is reading the temperature of the HTF at the top of the water jacket, at the rear of the HEATMOR™. The hot supply HTF is taken from the bottom of the water jacket at the rear of the HEATMOR™.
- 2) The high limit aquastat is reading the temperature from the top of the water jacket, at the rear of the HEATMOR™.
- 3) Until the HTF is thoroughly mixed, whether or not the unit is firing, there will be variances between the different instruments.

**IN A NORMAL OPERATING MODE, SMALL VARIANCES IN READINGS AND CALIBRATIONS WILL NOT AFFECT THE END RESULTS OF THE TOTAL SYSTEM.**



Electronic Aquastat Controller



Temperature Probe

### ELECTRICAL

#### Principles

The HEATMOR™ furnace comes with all internal components pre-wired. Provision is made for easy attachment of the main electrical power supply to the HEATMOR™ controls. Electrical outlets at the rear of the HEATMOR™ accommodate plugging in circulating pumps.

#### Electrical Supply



**Have a licensed electrician make all electrical connections.**

Required electrical power supply to the HEATMOR™ is 115 volts, 60HZ, 1 phase.

- 1) Use only 14/3 electrical wire.
- 2) The 14/3 wire will actually contain 4 wires; a) black, b) white, c) red, d) ground
- 3) If the electrical wire is being buried in the trench, be certain to use electrical wire approved for direct burial.
- 4) Do not place electrical wire in close contact with the supply and return lines.
- 5) The electrical supply wire should be connected to it's own circuit.
- 6) The red wire is used as a 120v signal back to the house that the Heatmor is in an Over-Temp situation.

#### Electrical Supply Junction Box

#### Principles

The electrical components of the HEATMOR™ furnace are pre-wired at the factory. All the wiring becomes centralized in the junction box.

#### Connecting the main power supply to the HEATMOR™:

- 1) Remove the plate on the Electrical Supply Junction Box.
- 2) Insert the electrical supply wire through the hole in the housing corner and route up the back into the supply junction box.
- 3) The Black wire is connected to the Mains Line. The White wire is connected to Mains Neutral. The Red wire is optionally connected to a circuit to dump heat or alert in an overheat condition. The Green wire is connected to the Earth Ground.
- 4) Tighten the screw clamp in the electrical connector to hold the supply wire firm.
- 5) Replace the plate on the Electrical Supply Junction Box.



Electrical Supply Junction Box

#### Maintenance

- 1) Keep the junction box clean and dry.
- 2) Keep the cover plate firmly attached at all times.
- 3) Make certain the MARR connectors (wire nuts) are properly installed and holding tight.

## Double Electrical Outlets at Rear

### *Principles*

To provide a live source of 115V power to power pumps, trouble lights, etc.

### *Maintenance*

- 1) Do not overload the circuit
- 2) Keep the outlets clean

## High Limit Safety Shutoff Control

The red wire leading from the HEATMOR™ back to the power source can be installed so the electrical power will sound an alarm or will override the comfortable heat settings within the heated building. By starting heating appliances in the building, heat will be drawn off the HEATMOR™, dumped into the building, creating an elevated temperature environment in the building, and hence a notification of an unusually high HTF temperature within the HEATMOR™. By removing this excess heat from the HEATMOR™, a "boil" will normally be avoided.

### *Operation*

- 1) This control is set at 200 degrees Fahrenheit. When the HTF temperature within the water jacket lowers to 195 degrees Fahrenheit; the electrical circuit to the main combustion air blower(s) would be re-activated. The combustion air blowers will not come back on until the low HTF temperature is reached.
- 2) Once the HTF temperature drops below 195 degrees Fahrenheit the Snap Disk High Limit will reset and your HEATMOR™ will function properly. To check turn light switch to down position, light should turn on. If not, check light bulb. If light bulb is fine, call your dealer.

### *Removal and Replacement*

- 1) Turn off the main power supply to the HEATMOR™.
- 2) Remove the back right side tray panel - 5/16th nut driver.
- 3) Make sure stove temperature is not hot.
- 4) Drain stove below aquastat bungs.
- 5) Remove electrical box cover.
- 6) Disconnect - Black - Brown - Red.
- 7) Pull wires - Black - Brown - Red.
- 8) Remove faulty High Limit with 1" wrench.
- 9) Insert new High Limit aquastat. Tighten - use Teflow tape on threads.
- 10) Pull wires - Black - Brown - Red through corner & electrical box.
- 11) Reconnect wires at junction box - Black - Brown - Red.
- 12) Replace junction cover.
- 13) Replace side tin.
- 14) Refill with HTF.
- 15) Turn power back on.



Electrical Supply Junction Box



High Temp Safety Shutoff

## Front Light and Fan Power Switch

### *Principles*

- 1) To provide light while fueling.
- 2) To provide a means of turning off the combustion air blowers on demand.
- 3) To provide a visual warning that electrical power to the combustion air blowers has been terminated.

### *Operation of the Front Light and Fan Power Switch*

- 1) By adjusting the fan power switch to the down position, the electrical power to the combustion air blower(s) is manually terminated, and the front light turns on.
- 2) This light will then illuminate the area in front of the HEATMOR™.
- 3) The light must be turned off for electrical power to be running to the combustion air blowers.

### *Removal and Replacement of the Front Light Bulb*

- 1) Remove the glass globe by first loosening the setscrew and then unscrew the globe.
- 2) Replace the light bulb.
- 3) Replace the globe and tighten the setscrew.

### *Removal and Replacement of the Fan Power/Light Switch*

- 1) Turn off the main electrical power supply to the HEATMOR™.
- 2) Remove the switch cover plate.
- 3) Make a sketch of the location of the wires on the switch.
- 4) Remove the wires, and replace the switch. This is a special 3-way switch.
- 5) Replace the wires as in the diagram.
- 6) Secure the cover plate.
- 7) Turn the main electrical power supply back on to the HEATMOR™.



Front Light & Fan Power Switch



Front Light

**IF THE HTF TEMPERATURE IS HIGH ENOUGH TO TRIGGER THE HIGH HTF TEMPERATURE SAFETY SHUTOFF, THE FRONT LIGHT WILL NOT TURN ON WHEN THE FAN POWER SWITCH IS IN THE DOWN POSITION.**

## In the Event of a Power Failure

If a power failure occurs during the use of a HEATMOR™, do not open the firebox door to provide draft for the fire to burn. Allow the fire to go out. In case of a prolonged power failure, a generator should be used as a back-up power source.



**It is recommended to contact a licensed electrician to perform the above operation.**

### EXTERIOR CLADDING AND INSULATION

#### Outer Front Door of the HEATMOR™

##### Principles of the Outer Front Door

The outer door of the furnace is an exterior door, which is insulated to retain the heat that radiates from the firebox door and water jacket surface. The door provides a lockable, protective surface to prevent any hot surface from being exposed.

##### Operation of the Outer Front Door

The outer door is hinged and opens to the right of the furnace. As the door opens, it releases the Automatic Fan Switch, which allows air to enter the air box reducing the risk of a flashback. A keyed lock is installed on the left side of the door providing an easy way to ensure the door cannot be opened causing untrained users to be injured.

##### Maintenance / Result

Keep the door free from any obstruction and ensure that the inner seal of the door seals against the doorframe. This will keep cold air from entering the heated air cavity, which provides the air box and firebox with air.

##### Removal and Replacement

To remove the outer door, the lock handle must be unlocked and opened. Pick up the old door from the hinges and place and secure the new door into position. Test the door to ensure a tight seal to the doorframe of the furnace.

#### Roof of the HEATMOR™

##### Principle of the Roof

The roof of the furnace is one solid piece of roofing steel creased in the center. This provides a dry covering to protect the insulation of the furnace.

##### Maintenance / Result

Inspect the roof of the furnace once a year to verify that none of the roof screws have broken. A large number of broken roof screws can allow damage to the furnace roof. Ensure the lift hook and chimney are sealed so no water can enter into the roof insulation.



Outer Front and Back Door



Lockable Door



Roof

**ABSOLUTELY NO FIRE IN THE FIREBOX WHEN PERFORMING THIS REPAIR. DO NOT PERFORM THIS REPAIR WHEN UNIT HTF TEMPERATURE IS UNSAFE. ALWAYS WEAR PROPER PERSONAL PROTECTIVE EQUIPMENT.**

#### Removal and Replacement

If the roof has been damaged it can be replaced. Follow these steps or contact your local dealer.

- 1) Remove the silicone from around the lift hook and vent pipe.
- 2) Remove all roof screws holding the damaged roof secure.
- 3) Lift the old roof steel off the furnace.
- 4) Install the new roof steel.
- 5) Secure the new roof to the frame of the furnace.
- 6) Re-seal the lift point and relief vent pipe with high temperature silicone.

#### Sides of the HEATMOR™

##### Principle of the Sides

The sides of the furnace are clad with your choice of steel siding. The steel siding provides a dry covering to protect the insulation of the furnace.

##### Maintenance / Result

Inspect the sides of the furnace once a year to verify that none of the screws have broken. A large number of broken screws can allow damage to the furnace siding. Ensure there is a good seal so no water can enter into the insulation covering the sides of the water jacket.

##### Removal and Replacement

If the sides have been damaged or if you would like to change the color of your unit, they can be replaced with different steel siding. Follow the following steps or contact your local dealer.

- 1) Remove all the screws holding the damaged steel siding secure.
- 2) Lift the old steel off the furnace.
- 3) Install the new steel siding.
- 4) Secure the new steel to the frame of the furnace.

#### Insulation

##### Principle of the Insulation

The insulation helps retain the heat in the HTF, which has been heated by the fire. It also provides a heat barrier to ensure that the outer steel siding does not release any heat.

##### Maintenance / Result

It is important to keep the insulation dry. Wet insulation loses its R-Value. Keep the base of the furnace sealed to prevent small rodents from making nests or wrecking the insulation.

##### Removal and Replacement

To remove and replace the insulation, refer to the preceding removal and replacement steps involving the roof and siding. If you have any further questions, please contact your local dealer.



Outer Side

### CHECKING FOR AIR LEAKS

Once your HEATMOR™ system is up and running, we recommend that you conduct an initial check for air leaks from the furnace. To detect an air leak, put some green grass (or something which will create heavy smoke) into the furnace. When the furnace is smoking, cover the chimney and turn off the blower and watch for smoke leaks.

Air leaks cause the fire to not burn as hot or efficiently. In result you will use more coal to achieve the desired HTF temperature. The HEATMOR™ Outdoor Furnace is designed with over / under forced drafts and if air leaks occur, it would change the output of the furnace.

**AIR LEAKS INTO THE FIREBOX WILL CAUSE  
THE FORMATION OF EXCESS CREOSOTE.**

### HEAT TRANSFER FLUID (HTF) LEAKS

If you suspect that your HEATMOR™ Stainless Steel Outdoor Furnace has developed a HTF leak, please contact your local dealer for verification and further details.



### DOMESTIC COIL (OPTIONAL)

#### *Principle of the Domestic Coil*

The domestic coil provides a method of heating HTF indirectly through water-to-water convection. This method of heating needs to be planned from the initial stages of purchasing your HEATMOR™. A HEATMOR™ Outdoor Furnace must be special ordered and manufactured with a special hole at the back of the furnace to accommodate the domestic coil.

#### *Operation of the Domestic Coil*

The coil is inserted at the rear of the furnace through a hole in the water jacket and fastened by nuts and bolts. The domestic coil plate is sealed to the outer face of the water jacket by a sealing gasket. As HTF passes through the domestic coil, the HTF in the water jacket heats it.

#### *Maintenance / Result*

- 1) Make sure a tight seal is maintained between the coil plate and the outer face of the water jacket.
- 2) Firmly fastened connections are essential to ensure there are no leaks.

#### *Removal and Replacement*

If you suspect you have a leak or faulty internal coil requiring replacement, contact your local dealer.

### MAINTENANCE CHECKLIST

#### Season Start-Up

To begin season start-up of your Heatmor™ Outdoor Furnace, assuming you followed the procedures outlined in the "End of Season Maintenance Checklist," follow the instructions below:

- 1) Remove cap from chimney.
- 2) Build fire in firebox and bring your furnace up to temperature. Refer to "Lighting the Heatmor™ for the First Time"
- 3) Once your furnace is up to temperature, you can start all pumps.
- 4) Your start-up is complete.



**CAUTION:** It is recommended to start your pumps AFTER you bring your furnace up to temperature. This helps ensure your system isn't air locked and ensure your HTF is circulating correctly.

#### End of Season

To begin End of Season Shutdown of your Heatmor™ Outdoor Furnace, follow the instructions below:

- 1) Turn off pump(s).
- 2) Clean Flue Refer to "Flue"
  - A) Remove the one-half inch nuts holding the flue cover and remove the cover.
  - B) Using the flue scraper provided with the HEATMOR™ furnace, push the dust to the front of the flue and let it fall down into the firebox. Remove this dust as you would ashes. If a lot of dust is dropped down, be certain that the air slot of the front air box is not covered.
  - C) Re-attach the flue cover plate, making sure to tighten the nuts to make an airtight seal.
- 3) Clean ashes out of Firebox. Refer to "Ashes"
  - A) Thoroughly pull ashes from sides and corners of Firebox. Rake ashes in Firebox down into the grates.
- 4) Auger ashes out of Ash Pan. Refer to "Ashes"
- 5) Place cap on Chimney. There is no specific product sold for this use, but a five gallon bucket or something similar will cover the chimney keeping unwanted moisture and visitors away.

- 6) Properly clean Fan(s). (Refer to the “Air Supply” section of the Heatmor™ Operations and Maintenance Manual.)
  - a) Turn off the main power supply to the furnace.
  - b) Loosen and remove the two thumb nuts securing the blower / flipper assembly to the large air tube, and remove the blower / flipper assembly.
  - c) With a small brush, scrape any dust or residue that has accumulated on the fins of the blower.
  - d) With a scraper or brush, remove any residue built up on the flipper assembly.
  - e) Ensure the flipper is resting completely on its seat. If it is not resting completely, perhaps there is dust or soot built up on the flipper, or some other obstruction not allowing it to close tightly.
  - f) Replace firebox door elbows every other season. If you did not change your firedoor elbows last year, it is strongly suggested to change them following the steps on page 43.
  - g) Securely fasten the blower / flipper assembly back to the large air tube ensuring there are no air leaks.
- 8) Check the Heat Transfer Fluid (HTF) to make sure there is the appropriate amount of DOWFROST™ HD mix in with your approved water. Refer to [“Heat Transfer Fluid”](#)
- 9) Take HTF sample and Mail to **HEATMOR™, Box 787, Warroad, MN 56763** as per annual requirement to keep warranty valid

**NOTE:** The HTF in the HEATMOR™ must be chemically analyzed once per year to ensure the proper levels of treatment are being maintained. Provide 20 ounces in a clean container and mail to HEATMOR™. When test results return, you must comply with any instructions given by HEATMOR™ or it may void your warranty.

### FREQUENTLY ASKED QUESTIONS

- Q. *How much Heat Transfer Fluid (HTF) should be in the bladder?***
- A.** When the furnace is initially filled, there should be about one inch of HTF in the bladder with the HTF at a temperature of 50 degrees Fahrenheit. When the furnace is at its operating temperature, the bladder should be at least 30% full. Overfilling the bladder can shorten the life of the bladder.
- Refer to:
- [“Maintaining the correct amount of HTF in the bladder and in the HEATMOR™”](#)
- Q. *Why is HTF coming out of the overflow relief vent pipe?***
- A.** When the furnace is initially filled and too much HTF is in the furnace, it releases through the relief vent pipe when the furnace is up to temperature. If this happens, a small amount of HTF should be removed from the furnace so the bladder is not hard.
- Refer to:
- [“Installation of the HEATMOR™ Furnace”](#)
- Q. *Why is my furnace wet on the inside of the firebox?***
- A.** When your furnace is first fired up, and also at times during normal operation, the atmosphere inside the firebox will exceed the dew point causing condensation.
- Refer to:
- [“Trouble Shooting and Solutions”](#) Furnace has excessive moisture in firebox
  - [“Dew Point”](#)
- Q. *Why does my furnace fail to respond to the switch at the front of the furnace? For example; the light will not come on and the fan will not operate?***
- A.** The High Limit Temperature Safety Shutoff Controller has probably overridden the operating Electronic Aquastat. If this has happened, it should also trigger your distribution system or high HTF temperature warning.
- Refer to:
- [“High Limit Temperature Safety Shutoff Controller”](#)
- Q. *Why is it getting so warm in my house and I cannot reduce the temperature with the thermostat?***
- A.** At this point the High Limit Temperature Safety Shutoff Controller has been tripped on. To detect the precise reason, please contact your local dealer.
- Refer to:
- [“High Limit Temperature Safety Shutoff Controller”](#)
- Q. *My furnace is shut down but still continues to increase in HTF temperature?***
- A.** There is an air leak somewhere in the furnace. Check all flippers and seals, ensuring that there is an airtight seal.
- Refer to:
- [“Checking for Air Leaks”](#)

**Q. Why am I experiencing an excess build up of creosote in the furnace?**

- A. You more than likely are introducing unwanted draft into the firebox. This may be caused by several things, including a door ajar, ash auger tube cover loose, flipper assembly stuck. If your furnace is in a location where wind may effect the pressure differential across the furnace, it could cause draft to leak past the flipper.

Refer to:

- “Creosote”

**Q. How do you change a door hose while the furnace is in operation?**

- A. Never change a door hose unless the furnace is cooled. Please refer to the firebox door hose section in the manual for further details or contact your local dealer.

Refer to:

- “Firebox Door Hoses”

**Q. My furnace combustion blower continues to run but the fire will not burn until I open the door?**

- A. Your flipper assembly is most likely stuck closed. Please refer to the combustion blower, flipper assembly section in the manual for further details or contact your local dealer.

- B. Pull flue cover off, check your flues, as well as chimney.

Refer to:

- “Combustion Air Blower and Flipper Assembly”

**Q. Fluid is coming out of the rectangular top chimney flue?**

- A. Similar to the firebox, when your furnace is initially fired up and also at times during normal operation, the atmosphere inside the firebox and chimney flue will exceed the dew point causing condensation.

Refer to:

- “Dew Point”

**Q. Can I burn wood?**

- A. The use of wood is only allowed for ignition purposes.

**Q. Why does my fan only turn on when the door is open?**

- A. If the light on the Electronic Aquastat controller is on, then you have low Heat Transfer Fluid.
- “Fluid Level Sensor”

### TROUBLESHOOTING AND SOLUTIONS

Main Principles to Remember

- Enough Coal
- Enough HTF
- Fans On - Air Must Get In
- Fans Off - Air Must Stay Out
- Heat Transfer Fluid (HTF) temperature between 165 and 180 degrees Fahrenheit

PROBLEM	CAUSE	SOLUTION	REFERENCE
<b>Furnace Boils</b>	Draft Flipper not closing 100%	Remove blower and flipper assembly	“ <u>Combustion Air Blower and Flipper Assembly</u> ”
	Blower, Flipper Assembly plate not tight	Tighten wing nuts	“ <u>Combustion Air Blower and Flipper Assembly</u> ”
	Ashes holding flipper open in air box(s)	Clean out ashes	“ <u>Air Box(s)</u> ”
	Firebox door improperly adjusted	Adjust Firebox Door	“ <u>Firebox Door</u> ”
	Firebox door ajar not shut tight	Close Fire Door tight	“ <u>Firebox Door</u> ”
	Ash Auger tube not sealed tight	Close Tube Cover firmly	“ <u>Ash Auger Tube Clover Plate</u> ”
	Door Gasket Damaged	Replaced Gasket	“ <u>Firebox Door Gasket</u> ”
	Base leaks Air	Reseal Base	“ <u>Caulking around the Firebox Base</u> ”
	Creosote buildup on firebox doorframe causing improper door seal	Remove creosote from doorframe	“ <u>Firedoor Frame</u> ”
	Wrong type of sand or not enough sand	Remove and replace or add sand	“ <u>Sand</u> ”

PROBLEM	CAUSE	SOLUTION	REFERENCE
	Very windy day causing a negative draft on the chimney	Consult Dealer	Local Dealer
<b>No Heat in Building</b>	Fire Out	Light Fire	<u>"Lighting your HEATMOR™"</u>
	HTF level low	Add HTF	<u>"HTF Level Maintenance"</u>
	Power Loss		<u>"Electrical Supply"</u>
	Pump Malfunction	Replace Pump or Cartridge	Local Dealer
	Air trapped in water lines	Bleed lines	Local Dealer
	Malfunction of heating appliances in building	Repair, adjust or replace	Local Dealer
<b>Furnace won't burn properly or maintain HTF</b>	Chimney plugged	Clean Chimney	<u>"Chimney"</u>
	Not enough coal in Firebox	Add coal	<u>"Loading Coal into the HEATMOR™"</u>
	Draft flipper stuck	Remove blower and flipper assembly. Clean, lube, or replace	<u>"Steps to Maintain"</u>
	Electrical power is off or not constant	Check all electrical connections.	<u>"Electrical"</u> Local Dealer
	Fire is out	Re-light fire	<u>"Lighting your HEATMOR™"</u>

PROBLEM	CAUSE	SOLUTION	REFERENCE
	Flue Plugged	Clean flue	<u>"Top Rectangular Flue"</u>
	Blower fins are full of dust	Clean blowers	<u>"Steps to Maintain your Blower and Flipper Assembly"</u>
	Blowers not running properly or up to speed	Clean blowers	<u>"Steps to Maintain your Blower and Flipper Assembly"</u>
	Ashes in Air Box(s)	Clean Air Box(s)	<u>"Air Box(s)"</u>
	Too many ashes in Firebox restricting air flow	Clean out ashes with Auger	<u>"Ash Management and Ash Removal"</u>
	Restricted air flow into Blower(s) air inlet	Clean Blowers	<u>"Steps to Maintain your Blower and Flipper Assembly"</u>
	Too much heat draw on furnace	Verify furnace size for application	Local Dealer
	Heat Transfer Fluid (HTF) to low	Add HTF	<u>"Filling the HEATMOR™ Outdoor Furnace Initially with HTF"</u>
<b>Furnace has excessive moisture in Firebox</b>	Chimney plugged	Clean Chimney	<u>"Chimney Stub/Chimney Extension(s)"</u>
	Flue Plugged	Clean flue	<u>"Top Rectangular Flue"</u>
	Ashes in Airbox(s)	Clean Air Box(s)	<u>"Air Box"</u>
	Too many ashes in Furnace	Clean out ashes	<u>"Ash Management and Removal"</u>

PROBLEM	CAUSE	SOLUTION	REFERENCE
Furnace boils or rattles before reaching maximum Temp.	HTF Temperature range to broad	Reduce Temperature	<a href="#">“Electrical (HTF Temperature Range Control)”</a>
	Operating temperature to high	Maximum temp. setting should not exceed 180° F	<a href="#">“Electrical (HTF Temperature Range Control)”</a>
<b>Firebox Door pops or Rattles</b>	Loading fuel too close to the firebox door	Load your fuel away from the firebox door	<a href="#">“Loading Coal into the HEATMOR™”</a>
	HTF Temp. range setting is too wide	Adjust aquastat spread setting closer	<a href="#">“Electrical (HTF Temperature Range Control)”</a>
<b>Building too warm</b>	Defective in-house thermostat	Replace thermostat	Local Dealer
	Aquastat malfunction	Replace Aquastat	<a href="#">“Electrical (HTF Temperature Range Control)”</a>
	Outdoor furnace is overheating	Check for air leaks	<a href="#">“Checking for Air Leaks”</a>
	Controls for heating appliances in building need to be adjusted	Adjust, relocate, add more controls to monitor & control Heat	Local Dealer
<b>Creosote Build-Up</b>	Air leakage around door	Replace Door Gasket	<a href="#">“Firebox Door Gasket”</a>
	Firebox receiving air somewhere when fans are off	Check all seals for air leaks. Run a smoke check	<a href="#">“Checking for Air Leaks”</a>
	Fire is not burning hot	Check type of coal burning & if blowers working properly	<a href="#">“Types of Coal, Combustion Air Blowers/ Flipper Assemblies”</a>
	Air flow is not sufficient for the type of fuel	Check and clean fan blades. Check & clean flipper assembly	<a href="#">“Combustion Air Blowers/ Flipper Assemblies”</a>

PROBLEM	CAUSE	SOLUTION	REFERENCE
	Ashes in Air Box(s)	Clean Air Box(s)	<a href="#">“Air Box”</a>
	Chimney Plugged	Clean Chimney	<a href="#">“Chimney Stub”</a>
	Flue Plugged	Clean Flue	<a href="#">“Top Rectangular Flue”</a>
<b>Charcoal build-up in rear of firebox</b>	Excessive Ashes	Remove Ashes	<a href="#">“Ash Management and Ash Removal”</a>
	Faulty back blower (400CB ONLY)	Replace Blower	<a href="#">“Combustion Air Blowers/ Flipper Assemblies”</a>
	Back blower has air flow restrictions	Clean Blower and Air Box	<a href="#">“Combustion Air Blowers/ Flipper Assemblies, Air Box(s)”</a>
	Failure to rake ashes periodically	Rake ashes	<a href="#">“Ash Management and Ash Removal”</a>
<b>Blowers continue to operate and not shut off</b>	Defective Automatic Fan Switch (AFS)	Replace AFS	<a href="#">“Automatic Fan Switch”</a>
<b>Too Much Smoke comes out firebox door when loading</b>	Opening firebox door when there's still fuel inside	Do not add so much fuel at one time	<a href="#">“Loading Coal into the HEATMOR™”</a>
	Opening door within 30-45 Seconds of blowers turning off	Open door sooner or wait for next cycle to start	<a href="#">“Loading Coal into the HEATMOR™”</a>
	Furnace pad has not been raised above ground level	Raise pad	Local Dealer
	Draft fan has not been turning off while loading	Turning off fan before loading	<a href="#">“Loading Coal into the HEATMOR™”</a>

PROBLEM	CAUSE	SOLUTION	REFERENCE
<b>Losing HTF</b>	Furnace is boiling	Add HTF. Complete a full furnace check of all systems	<u>"Filling the Furnace Initially with HTF"</u>
	Very slow leak somewhere in the system	Check and tighten any leaking fittings	Local Dealer
	Someone has accidentally opened a valve and not told anyone	Check valves and add HTF	<u>"HTF Level Maintenance"</u>
	Leaking water line	Fix leak in water line	Local Dealer
	Bladder is leaking	Replace Bladder	<u>"Bladder"</u>
	Door hoses are leaking	Replace door hoses	<u>"Firebox Door Hoses and Elbows"</u>
	Hose clamps are leaking	Tighten hose clamps	Local Dealer
<b>Smoke from chimney is an annoyance</b>	Chimney is not high enough	Add chimney extension	<u>"Chimney Extension(s)"</u>
	Improper location of furnace. Draft blowers have just turned off	Possibly relocate furnace.	Local Dealer
	Burning garbage	DO NOT BURN GARBAGE	Local Dealer
<b>Burning what seems like a lot of coal</b>	Losing heat into the ground. Poor insulation	Re-insulate water lines and maintain a dry perimeter	Local Dealer
	Ground water is extracting heat from the water lines	Provide a method for ground water to drain	Local Dealer

PROBLEM	CAUSE	SOLUTION	REFERENCE
	Top flue is clogged	Clean top flue	<u>"Top Rectangular Flue"</u>
	Using more heat in building than you realize	Verify furnace size for complete applications	Local Dealer
<b>Can't get building(s) warm enough</b>	Insufficient heating devices in building	Call your Local Dealer	Local Dealer
	Improperly installed heating devices in building	Correct installation of heating devices	Local Dealer
	Heating devices need maintenance	Maintain heating devices	Local Dealer
	HEATMOR™ not running between 160°F - 180°F	Adjust Aquastat	<u>"Electrical Aquastat Controller"</u>
	Insufficient HTF circulation from HEATMOR™	A) Check circulating pumps, replace if needed B) Kinked line	Local Dealer
		C) Air in system D) Pump is too small or has a restriction E) Lines are too small	Local Dealer
	One appliance getting more than its share of the flow of HTF	Adjust the flow of HTF to the different heating appliances	Local Dealer
	Defective thermostat and controls in building	Replace thermostat and controls	Local Dealer
	Faulty electrical supply	Check electrical connections and check	Electrician
	Indoor forced air fan is plugged, reducing air flow through coil	Call your Local Dealer	Local Dealer

PROBLEM	CAUSE	SOLUTION	REFERENCE
	Improper installation of coil in forced air furnace	Call your Local Dealer	Local Dealer
	Too small a coil in forced air furnace	Call your Local Dealer	Local Dealer
	Inadequate Baseboard	When a water-to-water heat exchanger is installed a temp drop of 20-30°F across heat exchanger may be experienced	Local Dealer
<b>Not enough domestic hot water</b>	Hot water heater is too small	Sidearm exchanger needs to have a pump installed	Local Dealer
	Hot and cold water can mix in domestic system resulting in warm water	Call your Local Dealer	Local Dealer
	HTF temperature not consistently between 160-180°F	Adjust New Style High-Limit	Local Dealer
	Sidearm clogged with scale (lime), restricting or closing off flow	Call your Local Dealer	Local Dealer
<b>Fluid in auger tube</b>	Condensation formation on cooler steel	Maintain constant firebox temperature	<u>"Ash Auger Tube"</u>

Warranty can be found at  
<https://heatmor.com/warranty/>



## HEATMOR™ REFERRAL

Any registered Heatmor Outdoor Furnace owner that is listed as the 1<sup>st</sup> referral contact for a Heatmor Furnace sold after July 1, 2020 will be mailed a \$100 check for each confirmed referral after the sale of the new furnace is finalized and the warranty is sent in. The Purchaser of a new Heatmor will receive \$100 off their purchase.

- ◆ Only Heatmor owners that have valid warranties are eligible
- ◆ Referral will be verified by lead information and warranty information
- ◆ A \$100 check will then be sent to the Heatmor owner, verified from warranty information on file
- ◆ There is no limit to how many referrals can be made

**NOTE:** Only registered Heatmor Outdoor Furnace owners are eligible. The Heatmor Distributor / Dealer Network is NOT eligible.

The following 2 sources must be verified in writing for an eligible referral:

- 1) Heatmor owners must be identified as the referral source in writing on lead information gathered through Heatmor, Inc., Heatmor Dealers, or Heatmor Distributors
- 2) Heatmor owners must be identified as the referral source in writing on a returned warranty registration after the purchase

All checks will be issued in U.S. Funds.

If you have any questions please contact your distributor.



100 / 200 / 350 / 400 / 450

Rev 4 Spring 2016 to Present

